

FLUKE®

Calibration

1594A/1595A
Super-Thermometer
Technical Guide

Limited Warranty & Limitation of Liability

Each product from Fluke Corporation (“Fluke”) is warranted to be free from defects in material and workmanship under normal use and service. The warranty period is one year(s) for the thermometer. The warranty period begins on the date of the shipment. Parts, product repairs, and services are warranted for 90 days. The warranty extends only to the original buyer or end-user customer of a Fluke authorized reseller, and does not apply to fuses, disposable batteries or to any other product, which in Fluke’s opinion, has been misused, altered, neglected, or damaged by accident or abnormal conditions of operation or handling. Fluke warrants that software will operate substantially in accordance with its functional specifications for 90 days and that it has been properly recorded on non-defective media. Fluke does not warrant that software will be error free or operate without interruption. Fluke does not warrant calibrations on the Super-Thermometer.

Fluke authorized resellers shall extend this warranty on new and unused products to end-user customers only but have no authority to extend a greater or different warranty on behalf of Fluke. Warranty support is available if product is purchased through a Fluke authorized sales outlet or Buyer has paid the applicable international price. Fluke reserves the right to invoice Buyer for importation costs of repairs/replacement parts when product purchased in one country is submitted for repair in another country.

Fluke’s warranty obligation is limited, at Fluke’s option, to refund of the purchase price, free of charge repair, or replacement of a defective product which is returned to a Fluke authorized service center within the warranty period.

To obtain warranty service, contact your nearest Fluke authorized service center or send the product, with a description of the difficulty, postage, and insurance prepaid (FOB Destination), to the nearest Fluke authorized service center. Fluke assumes no risk for damage in transit. Following warranty repair, the product will be returned to Buyer, transportation prepaid (FOB Destination). If Fluke determines that the failure was caused by misuse, alteration, accident or abnormal condition or operation or handling, Fluke will provide an estimate or repair costs and obtain authorization before commencing the work. Following repair, the product will be returned to the Buyer transportation prepaid and the Buyer will be billed for the repair and return transportation charges (FOB Shipping Point).

THIS WARRANTY IS BUYER’S SOLE AND EXCLUSIVE REMEDY AND IS IN LIEU OF ALL OTHER WARRANTIES, EXPRESS OR IMPLIED, INCLUDING BUT NOT LIMITED TO ANY IMPLIED WARRANTY OF MERCHANTABILITY OR FITNESS FOR A PARTICULAR PURPOSE. FLUKE SHALL NOT BE LIABLE FOR ANY SPECIAL, INDIRECT, INCIDENTAL. OR CONSEQUENTIAL DAMAGES OR LOSSES, INCLUDING LOSS OF

Fluke Corporation

799 E. Utah Valley Drive • American Fork, UT 84003-9775 • USA

Phone: +1.801.763.1600 • Telefax: +1.801.763.1010

E-mail: support@hartscientific.com

www.hartscientific.com

Specifications subject to change without notice. • Copyright © 2008 • Printed in USA

Table of Contents

1	Before You Start	1
1.1	Symbols Used.....	1
1.2	Safety Information.....	1
1.2.1	WARNINGS	1
1.2.2	CAUTIONS.....	2
1.3	Authorized Service Centers.....	2
2	Introduction and Specifications	5
2.1	Introduction.....	5
2.2	Specifications	5
2.2.1	General.....	5
2.2.2	Primary Specifications.....	6
2.2.2.1	Resistance Ratio Accuracy.....	6
2.2.2.2	Resistor Stability	6
2.2.2.3	Absolute Resistance Accuracy.....	7
2.2.2.4	Measurement Current Accuracy.....	7
2.2.3	Ancillary Specifications	8
2.2.3.1	Temperature Measurement Noise.....	8
2.2.3.2	Relative Measurement Current Accuracy.....	8
2.2.4	General Specifications	9
2.2.5	Applying the Specifications	9
2.2.5.1	Introduction.....	9
2.2.5.2	How the Super-Thermometer Measures.....	9
2.2.5.3	Example 1: Measuring an SPRT	10
2.2.5.4	Example 2: Calibrating an SPRT.....	12
2.2.5.5	Example 4: Measuring a 100 Ω PRT.....	13
2.2.5.6	Example 5: Measuring a 10 k Ω Thermistor	14
3	Preparation for Operation.....	15
3.1	Unpacking and Inspection	15
3.2	Instruction Manuals.....	15
3.3	Line Voltage and Fuses	15
3.4	Connecting to Line Power.....	16
3.5	Placement and Rack Mounting.....	16
4	Front and Rear Panel Features	17
4.1	Introduction.....	17
4.2	Front Panel Features.....	17
4.2.1	Measurement Inputs	17
4.2.2	USB Connection.....	17
4.2.3	Front Panel Keys	18
4.2.3.1	Front Panel Display.....	19
4.3	Rear Panel Features	20
4.3.3.1	External Resistor Inputs.....	20
4.3.1	Scanner Connection.....	20
4.3.2	Future Peripheral Connection	21
4.3.3	Remote Operation Connections.....	21
4.3.4	Line Voltage Connection	22

4.3.5	Earth Ground Connection	22
5	Menus and Screens	23
5.1	Introduction.....	23
5.2	Changing Settings	23
5.3	Password Protection	24
5.4	Menu Navigation.....	24
5.5	Menu System	24
5.6	Measurement Screen.....	25
5.6.1	Channel Measurement Display	26
5.6.2	Channel Summary Section.....	26
5.6.3	Statistics Fields	27
5.6.4	Data/Graph Section.....	27
5.6.5	Status and Alert Section.....	27
5.6.6	START/STOP MEASUREMENT (F1)	28
5.6.7	SHOW TABLE/GRAPH (F2)	28
5.6.8	RESET STATISTICS (F3)	28
5.6.9	CLEAR GRAPH/CLEAR MESSAGE (F4)	28
5.6.10	START/STOP RECORD (F5)	28
5.7	Main Menu	28
5.7.1	CHANNEL SETUP (F1).....	29
5.7.1.1	ASSIGN PROBE (F1)	29
5.7.1.2	CHANNEL SETTINGS (F2).....	30
5.7.2	PROBE MENU (F2).....	34
5.7.2.1	ADD PROBE (F1)	34
5.7.2.2	COPY PROBE (F2).....	36
5.7.2.3	EDIT PROBE (F3).....	36
5.7.2.4	READ PROBE (F4).....	37
5.7.2.5	MANAGE PROBES (F5)	37
5.7.3	MEASURE MENU (F3).....	38
5.7.3.1	SCAN SETTINGS (F1).....	39
5.7.3.2	TIMING SETTINGS (F2).....	39
5.7.3.3	DIGITAL FILTER (F3).....	41
5.7.3.4	RECORDING MENU (F4).....	41
5.7.3.5	ZERO-POWER MEASUREMENT (F5).....	43
5.7.4	DISPLAY MENU (F4)	46
5.7.4.1	USER SETTINGS (F1)	47
5.7.4.2	FIELD SETTINGS (F2)	48
5.7.4.3	STATISTICS SETTINGS (F3).....	49
5.7.4.4	GRAPH SETTINGS (F4).....	49
5.7.4.5	TEMPERATURE UNIT (F5).....	50
5.7.5	SYSTEM MENU (F5).....	50
5.7.5.1	TIME DATE (F1)	50
5.7.5.2	REMOTE INTERFACE (F2).....	51
5.7.5.3	CONFIG (F3).....	52
5.7.6	RECALL CONFIG (F2).....	53
5.7.7	DELETE CONFIG (F3).....	54
5.7.7.1	PASSWORD (F4).....	54
5.7.7.2	CALIBRATION (F5)	55
6	Getting Started	57
6.1	Powering on the Super-Thermometer.....	57

6.2	User Settings Screen	57
6.3	Connecting a Probe or Resistor.....	58
7	Making Measurements	61
7.1	Introduction.....	61
7.2	Measuring a Temperature Probe	61
7.3	Scanning Multiple Temperature Probes.....	62
7.4	Measuring Resistance Ratio	62
7.5	Configuring an External Reference Resistor.....	62
7.6	Making A Zero-Power Measurement	63
8	Remote Operation	65
8.1	Introduction.....	65
8.2	Configuring the Network (LAN) Port	65
8.2.1	Hardware Mac Address	66
8.2.2	Selecting Dynamic Host Configuration Protocol (DHCP).....	66
8.2.3	Setting a Static Internet Protocol (IP) Address.....	66
8.2.4	Setting the LAN Gateway Address	67
8.2.5	Setting the LAN Subnet Mask	67
8.2.6	Setting the Host Name	67
8.3	Using the Web Interface.....	68
8.4	Configuring the USB Port.....	68
8.5	Configuring the RS-232 Serial Port.....	69
8.6	Configuring the IEEE-488 Port.....	69
8.7	Interface Commands	70
8.7.1	Command Syntax.....	70
8.7.2	List of Commands	70
8.7.3	Descriptions of Commands.....	74
8.7.3.1	*CLS.....	74
8.7.3.2	*ESE <value>.....	74
8.7.3.3	*ESR?.....	74
8.7.3.4	*IDN?	75
8.7.3.5	*RST.....	75
8.7.3.6	*SRE <value>	75
8.7.3.7	*STB?	76
8.7.3.8	CAL:DATE <year>,<month>,<day>	76
8.7.3.9	CAL:PAR:LIN<n> <value>	76
8.7.3.10	CAL:PAR:RES<n> <value>	76
8.7.3.11	CAL:PAR:ZERO <value>	76
8.7.3.12	CALC<n>:AVER:ALL?	77
8.7.3.13	CALC<n>:AVER:AVER?.....	77
8.7.3.14	CALC[<n>]:AVER:CLEA	77
8.7.3.15	CALC:AVER:COUN <value>	77
8.7.3.16	CALC<n>:AVER:MAX?	78
8.7.3.17	CALC<n>:AVER:MIN?	78
8.7.3.18	CALC<n>:AVER:SDEV?.....	78
8.7.3.19	CALC<n>:AVER:SEM?	79
8.7.3.20	CALC<n>:AVER:SPR?	79
8.7.3.21	CALC<n>:AVER:SSIZ?	79
8.7.3.22	CALC:AVER:TCON NORM MOV	79
8.7.3.23	CALC:DELT:CHAN <channel>	79

8.7.3.24	CALC<n>:DELT:DATA?	80
8.7.3.25	CALC:DELT:MODE OFFS CHAN	80
8.7.3.26	CALC:DELT:OFFS <value>	80
8.7.3.27	CALC<n>:TYPE TEMP RES RAT	80
8.7.3.28	DATA:REC:ALL <boolean>	80
8.7.3.29	DATA:REC:FILE <name>	81
8.7.3.30	DATA:REC:MEM INT USB BOTH	81
8.7.3.31	DATA:REC[:STAT] <boolean>	81
8.7.3.32	DISP:ALER:CLEA	81
8.7.3.33	DISP:ALER[:READ]?	81
8.7.3.34	DISP:DATE:FORM YMD DMY MDY	81
8.7.3.35	DISP:DEC:FORM PER COMM	81
8.7.3.36	DISP:FIEL:FEED<n>?	81
8.7.3.37	DISP:FIEL:MEM <n>	82
8.7.3.38	DISP:FIEL:MEM<n1>:FEED<n2> <feed>	82
8.7.3.39	DISP:HELP <boolean>	82
8.7.3.40	DISP:LANG ENGLISH CHINESE JAPANESE SPANISH GERMAN FRENCH RUSSIAN	82
8.7.3.41	DISP:TEMP:DIG <digits>	82
8.7.3.42	DISP:WARN:DUE <boolean>	82
8.7.3.43	DISP:WARN:ITS <boolean>	83
8.7.3.44	FETC? <channel>	83
8.7.3.45	INIT:CONT <boolean>	83
8.7.3.46	INIT:STOP:BEEP <boolean>	83
8.7.3.47	INIT:STOP:DUR <value>	83
8.7.3.48	INIT:STOP[:STAT] <boolean>	84
8.7.3.49	INIT:STOP:TIME?	84
8.7.3.50	INP<n>:CURR <current>	84
8.7.3.51	INP<n>:CURR:DATA?	84
8.7.3.52	INP<n>:CURR:STAN <boolean>	84
8.7.3.53	INP:PROB:ADD <id>	84
8.7.3.54	INP:PROB:COUN?	85
8.7.3.55	INP:PROB:DEL <id>	85
8.7.3.56	INP:PROB:FIRS?	85
8.7.3.57	INP<n>:PROB:IDEN <id>	85
8.7.3.58	INP:PROB:NEXT?	85
8.7.3.59	INP:PROB:PAR <id>,<name>,<value>	86
8.7.3.60	INP:PROB:TEST? <id>,<resistance>	87
8.7.3.61	INP:REAR<n>:RS:IDEN <id> VAR NONE	87
8.7.3.62	INP:RS:ADD <id>	88
8.7.3.63	INP:RS:COUN?	88
8.7.3.64	INP:RS:DEL <id>	88
8.7.3.65	INP:RS:FIRS?	88
8.7.3.66	INP<n>:RS:IDEN <id> VAR NONE	88
8.7.3.67	INP:RS:NEXT?	89
8.7.3.68	INP:RS:OVEN:STAB?	89
8.7.3.69	INP:RS:PAR <id>,<name>,<value>	89
8.7.3.70	INP<n>:RS:ROUT <source>	89
8.7.3.71	ROUT:CLOS <channel>	90
8.7.3.72	ROUT:CLOS:STAT?	90
8.7.3.73	ROUT:SCAN <channel list>	90
8.7.3.74	ROUT:SCAN:ADD <channel list>	91
8.7.3.75	ROUT:SCAN:ALT <boolean>	91
8.7.3.76	ROUT:SCAN:DEL <channel list>	91
8.7.3.77	ROUT:SCAN:REF <channel>	91
8.7.3.78	ROUT:SCAN:REP <value>	91
8.7.3.79	ROUT:SCAN:STAT <boolean>	92

8.7.3.80	SENS:APER[:DISP] <time>.....	92
8.7.3.81	SENS:APER:PRES NORM PREC FAST LONG	92
8.7.3.82	SENS:APER:SAMP <time>	92
8.7.3.83	SENS:AVER1[:STAT] <boolean>.....	92
8.7.3.84	SENS:AVER2[:STAT] <boolean>.....	93
8.7.3.85	SENS:AVER2:COUN <count>	93
8.7.3.86	SENS:AVER2:CLEA.....	93
8.7.3.87	SENS[<n>][:FRES]:DATA?.....	93
8.7.3.88	SENS[<n>]:RRAT:DATA?.....	93
8.7.3.89	STAT:OPER?.....	94
8.7.3.90	STAT:OPER:COND?	94
8.7.3.91	STAT:OPER:ENAB <value>	94
8.7.3.92	STAT:QUES?.....	94
8.7.3.93	STAT:QUES:COND?	94
8.7.3.94	STAT:QUES:ENAB <value>.....	94
8.7.3.95	SYST:BEEP[:IMM]	95
8.7.3.96	SYST:BEEP:KEY <boolean>	95
8.7.3.97	SYST:BEEP:ALER <boolean>	95
8.7.3.98	SYST.CODE:VERS?.....	95
8.7.3.99	SYST.COMM:GPIB:ADDR <value>.....	95
8.7.3.100	SYST.COMM:GPIB[:STAT] <boolean>	95
8.7.3.101	SYST.COMM:GPIB:TERM LIN RET	95
8.7.3.102	SYST.COMM:SER:BAUD <value>	95
8.7.3.103	SYST.COMM:SER:LIN <boolean>	95
8.7.3.104	SYST.COMM:SOCK:ADDR <IP address>	95
8.7.3.105	SYST.COMM:SOCK:CONT OFF ON QUER.....	96
8.7.3.106	SYST.COMM:SOCK:DHCP <boolean>.....	96
8.7.3.107	SYST.COMM:SOCK:GAT <IP address>	96
8.7.3.108	SYST.COMM:SOCK:KEEP <seconds>	96
8.7.3.109	SYST.COMM:SOCK:MAC?.....	97
8.7.3.110	SYST.COMM:SOCK:MASK <IP address>	97
8.7.3.111	SYST.COMM:SOCK:NAME <name>	97
8.7.3.112	SYST.COMM:USB[:STAT] <boolean>	97
8.7.3.113	SYST.CONF:CHAN?.....	97
8.7.3.114	SYST.CONF:SCAN?	97
8.7.3.115	SYST.DATE <year>,<month>,<day>.....	97
8.7.3.116	SYST.ERR?.....	98
8.7.3.117	SYST.KLOC <boolean>	98
8.7.3.118	SYST.PASS:CDIS.....	98
8.7.3.119	SYST.PASS:CEN <password>	98
8.7.3.120	SYST.PASS:CEN:STAT?.....	99
8.7.3.121	SYST.PASS:GROU:MEAS <boolean>.....	99
8.7.3.122	SYST.PASS:GROU:PROB <boolean>.....	99
8.7.3.123	SYST.PASS:GROU:RES <boolean>.....	99
8.7.3.124	SYST.PASS:GROU:TIME <boolean>	99
8.7.3.125	SYST.PASS:NEW <current password>,<new password>	99
8.7.3.126	SYST.PON:MIN?.....	99
8.7.3.127	SYST.TIME <hour>,<minute>,<second>	99
8.7.3.128	SYST.TIME:DAYL OFF NAM EUR	99
8.7.3.129	TEST.CURR:CONF <channel>,<current>,<polarity>.....	100
8.7.3.130	TEST.CURR[:STAT] <boolean>.....	100
8.7.3.131	TEST.LIN:ABOR	100
8.7.3.132	TEST.LIN:PAR?.....	100
8.7.3.133	TEST.LIN:INIT.....	100
8.7.3.134	TEST.LIN:REP<n>?	101
8.7.3.135	TEST.LIN:REP:TIME?.....	101

8.7.3.136	TEST:LIN[:STAT]?	101
8.7.3.137	TEST:LIN:TIME?	101
8.7.3.138	TEST:LIN:TOL<n>?	102
8.7.3.139	TEST:SYST:ABOR	102
8.7.3.140	TEST:SYST:INIT	102
8.7.3.141	TEST:SYST:REP[<n>]?	102
8.7.3.142	TEST:SYST:STAT?	102
8.7.3.143	UNIT:TEMP C K F	102
9	Calibration	103
9.1	Introduction	103
9.2	SYSTEM TEST (F1)	103
9.3	CURRENT TEST (F2)	103
9.4	RATIO CALIBRATION (F3)	104
9.4.1	WRITE FILE (F1)	106
9.4.2	ADJUST PARAMETERS (F2)	106
9.5	RESISTANCE CALIBRATION (F4)	106
9.5.1	WRITE FILE (F1)	107
9.5.2	ADJUST RESISTOR (F2)	108
9.6	CALIBRATION PARAMETERS (F5)	108
9.6.1	Calibration Interval	108
9.6.2	Standby Current Check	109
10	Maintenance	111
11	Troubleshooting	113
11.1	CE Comments	114
11.1.1	EMC Directive	114
11.1.1.1	Immunity Testing	115
11.1.1.2	Emission Testing	115
11.1.2	Low Voltage Directive (Safety)	115
Index		117

Figures

Figure 1 PEM (Power Entry Module).....	16
Figure 2 Front view	17
Figure 3 Front Panel Display.....	19
Figure 4 Rear view	20
Figure 5 External Resistor Inputs.....	20
Figure 6 Power Entry Module.....	22
Figure 7 Location Descriptor Example	23
Figure 8 Alpha-Numeric Interface	23
Figure 9 Measurement Screen.....	26
Figure 10 Channel Setup Screen.....	29
Figure 11 Probe Menu Screen	34
Figure 12 Measure Menu Screen.....	38
Figure 13 Measurement Process Block Diagram	39
Figure 14 Display Menu Screen.....	46
Figure 15 System Menu Screen.....	50
Figure 16 Input Wiring	58
Figure 17 Super-Thermometer Web Interface	68
Figure 18 Current meter connection diagram.....	103

Tables



















Table 1 Symbols.....1
Table 2 Resistance Ratio Accuracy Specifications6
Table 3 Resistor Stability Specifications7
Table 4 Absolute Resistance Accuracy Specifications7
Table 5 Measurement Current Accuracy Specifications.....8
Table 6 Temperature Measurement Noise Specifications.....8
Table 7 Relative Measurement Current Specifications8
Table 8 General Specifications9
Table 9 Optional Accessories15
Table 10 Front panel key descriptions18
Table 11 Remote Operation Connections.....21
Table 12 Alert Messages27
Table 13 Recommended Reference Resistor for Various Probe Types30
Table 14 Probe Conversion Information.....35
Table 15 Default Statistical Fields.....48
Table 16 Statistical Field Descriptions48
Table 17 Recommended Reference Resistors and Sensing Current62
Table 18 Remote Operation Ports.....65
Table 19 Report Operation Commands70
Table 20 Recommended Resistors For Testing The Current 104

1 Before You Start

1.1 Symbols Used

Table 1 lists the symbols that may be used on the instrument or in this manual and the meaning of each symbol.

Table 1 Symbols

Symbol	Description	Symbol	Description
	AC (Alternating Current)		PE Ground
	AC-DC		Hot Surface (Burn Hazard)
	Battery		Read the User's Guide (Important Information)
	Complies with European Union directives		Off
	DC		On
	Double Insulated		Standby Indication
	Electric Shock		Canadian Standards Association
	Fuse		C-TICK Australian EMC mark
	Ground		The European Waste Electrical and Electronic Equipment (WEEE) Directive (2002/96/EC) mark.

1.2 Safety Information

This instrument is compliant to EN 61010-1 {2nd Edition}, and CAN/CSA 22.2 No 61010.1-04, Pollution Degree 2. This instrument is designed for indoor use only. Use this instrument only as specified in this manual. Otherwise, the protection provided by the instrument may be impaired.

The following definitions apply to the terms “Warning” and “Caution”.

- “WARNING” identifies conditions and actions that may pose hazards to the user.
- “CAUTION” identifies conditions and actions that may damage the instrument being used.

1.2.1 WARNINGS

- **DO NOT** use this unit in environments other than those listed in the User's Guide.
- Follow all safety guidelines listed in the User's Guide.
- Calibration equipment should only be used by trained personnel.
- This instrument can measure extreme temperatures. Precautions must be taken to prevent personal injury or damage to objects. Probes may be extremely hot or cold. Cautiously handle probes to prevent personal injury. Carefully place probes on a heat/cold resistant surface or rack until they reach room temperature.
- **DO NOT** operate near flammable materials.
- Use only a grounded AC mains supply of the appropriate voltage to power the instrument.

- **DO NOT** connect an AC mains supply that does not match the voltage setting on the back of the unit.
- **DO NOT** use this instrument in combination with any probe (PRT or thermistor) to measure the temperature or resistance of any device where the probe might come in contact with a conductor that is electrically energized. Severe electric shock, personal injury, or death may occur.
- **DO NOT** position this instrument in a manner where it is difficult to reach the power cord or power entry module mains switch. When rack mounting the instrument, ensure the rack power cord and mains supply switch are accessible.

1.2.2 CAUTIONS

- If the instrument is dropped, struck, or handled in a way that causes internal or external physical damage, immediately unplug the instrument, discontinue use, and contact a Fluke Authorized Service Center for repair. Do not attempt to disassemble or repair the instrument. Refer repairs or replacement of components to a Fluke Authorized Service Center.
- **DO NOT** connect AC voltage to any input terminal on the instrument. Permanent damage to the instrument will result.

1.3 Authorized Service Centers

Please contact one of the following authorized Service Centers to coordinate service on your Fluke product:

Fluke Corporation

799 E. Utah Valley Drive
American Fork, UT 84003-9775
USA
Phone: +1.801.763.1600
Telefax: +1.801.763.1010
E-mail: support@hartscientific.com

Fluke Nederland B.V.

Customer Support Services
Science Park Eindhoven 5108
5692 EC Son
NETHERLANDS
Phone: +31-402-675300
Telefax: +31-402-675321
E-mail: ServiceDesk@fluke.nl

Fluke Int'l Corporation

Service Center - Instrimpex
Room 2301 Sciteck Tower
22 Jianguomenwai Dajie
Chao Yang District
Beijing 100004, PRC
CHINA
Phone: +86-10-6-512-3436
Telefax: +86-10-6-512-3437
E-mail: xingye.han@fluke.com.cn

Fluke South East Asia Pte Ltd.

Fluke ASEAN Regional Office
Service Center
60 Alexandra Terrace #03-16
The Comtech (Lobby D)
118502
SINGAPORE
Phone: +65 6799-5588
Telefax: +65 6799-5588
E-mail: antng@singa.fluke.com

When contacting these Service Centers for support, please have the following information available:

- Model Number
- Serial Number
- Voltage
- Complete description of the problem

2 Introduction and Specifications

2.1 Introduction

The Fluke family of Hart Super-Thermometers long ago established the standard for easy-to-use, precision temperature measurement instrumentation. Laboratories worldwide have selected the Super-Thermometer not only for the assurance of achieving high-quality results, but also for the innovative features that increase productivity in the lab. The Fluke 1594A and 1595A Hart Super-Thermometers continue this legacy adding new patent pending measurement technology and features that truly are best in class. Below is a summary of key capabilities and features.

- Typical 1595A accuracy 0.2 ppm (0.05 mK), 1594A accuracy 0.8 ppm (0.2 mK)
- Sample rates as fast as 1 second
- Measures SPRTs, HTPRTs, PRTs, and thermistors
- Four input channels on the front panel accept most probe terminations with the patented DWF, gold-plated, tellurium-copper, quick-connect terminals
- Configurable standby current for each input channel minimizes self-heating transients when scanning between channels
- Two input channels on the back panel, dedicated for external standard resistors, keep the front panel inputs free for Reference Thermometers or Standard Resistors and UUTs
- Channel Select Keys above each input channel change color to indicate whether a channel is actively measuring, in standby, or inactive—pressing a channel key activates the selected channel
- Temperature-controlled internal reference resistors allow for traceable temperature and absolute resistance measurements in ambient conditions from 15 °C to 30 °C
- Patent pending, Ratio Self-Calibration performs a linearity check or calibration of the Super-Thermometer ratio accuracy without the need of any external equipment
- Automated Zero-Power Measurement allows for determination and/or cancellation of a thermometer’s self-heating error
- Updated computer interface with USB control, RS-232, and IEEE-488 included as standard
- Ethernet connection allows for remote view of the Super-Thermometer’s display from a web browser
- USB memory device on the front panel to accommodate data logging, transfer of probe parameters, and storage and retrieval of Super-Thermometer user configurations
- VGA output allows the Super-Thermometer’s screen to be displayed on a VGA monitor
- Selectable operating language: English, Chinese, Japanese, Spanish, French, German, or Russian
- Intuitive User Interface makes the Super-Thermometer easy to configure and use right out of the box

2.2 Specifications

2.2.1 General

Current best practices in metrology require uncertainty analyses to be in compliance with the ISO *Guide to the Expression of Uncertainty in Measurement* (often referred to as the “GUM”). For convenience, the specifications in this section are listed in $k = 2$ (95%) coverage and in $k = 3$ (99%) coverage to allow the user to easily apply the specifications in an uncertainty analysis.

The following specifications apply after the standard warm-up period of 30 minutes. The Super-Thermometer is designed to measure with accuracy and stability without the need for internal auto-cal or zeroing routines. To realize the full potential of measurement ability, accepted metrology practices such as the use of proper wiring should be adhered to. In addition, it is important to ensure that the instrument is correctly set up.

The specifications are divided into three categories: primary specifications, ancillary specifications, and general specifications.

Primary Specifications: the core set of measurement accuracy specifications of the Super-Thermometer. They are guaranteed for performance verification at the 99% confidence level.

Ancillary Specifications: additional specifications that help the user understand more of the uncertainties involved in measurement. Since they may be subject to the application and setting in which the Super-Thermometer is used, they are not guaranteed for performance verification but should be considered typical.

General specifications: general specifications such as measurement range, environmental operating range, dimensions, etc.

2.2.2 Primary Specifications

2.2.2.1 Resistance Ratio Accuracy

Resistance ratio accuracy is the ability of the Super-Thermometer to measure the ratio of two resistances, R_x/R_s . It is determined primarily by the linearity of the measurement circuit. The following specifications apply for resistance ratios measured with a reference resistor of 25 Ω or 100 Ω using a measurement current of 0.5 mA to 2.0 mA. Other reference resistors are specified using a factor as explained in the following specification table. Performance verification is guaranteed for 99% confidence level specifications within the specified operating temperature range of 15°C to 30°C. The listed uncertainties are in terms of parts-per-million (ppm) of reading unless stated otherwise.

Table 2 Resistance Ratio Accuracy Specifications

Ratio Range	1594A Accuracy (ppm of reading)	1595A Accuracy (ppm of reading)
95% confidence level, 1-year		
0.95 to 1.05	0.24 ppm	0.06 ppm
0.5 to 0.95, 1.05 to 2.0	0.64 ppm	0.16 ppm
0.25 to 0.5, 2.0 to 4.0	0.8 ppm	0.2 ppm
0.0 to 0.25	$2.0 \times 10^{-07} \dagger$	$5.0 \times 10^{-8} \dagger$
4.0 to 10.0	2.0 ppm	0.5 ppm
99% confidence level, 1-year		
0.95 to 1.05	0.3 ppm	0.075 ppm
0.5 to 0.95, 1.05 to 2.0	0.8 ppm	0.2 ppm
0.25 to 0.5, 2.0 to 4.0	1.0 ppm	0.25 ppm
0.0 to 0.25	$2.5 \times 10^{-7} \dagger$	$6.3 \times 10^{-8} \dagger$
4.0 to 10.0	2.5 ppm	0.63 ppm
\dagger Specifications are in terms of absolute ratio		
All specifications listed in this table apply when using a 25 Ω or 100 Ω reference resistor. Multiply stated specifications by a factor of 2 when using a 10 Ω reference resistor with sensing current between 1 and 5 mA, and a factor of 10 when using a 1 Ω reference resistor with sensing current between 5 and 20 mA. When using a 10 kohm reference resistor, internal or external, use the Absolute Resistance Accuracy specification in Table 4.		

2.2.2.2 Resistor Stability

Resistor stability characterizes the ability of the instrument to accurately compare two similar resistances within some time period using the internal resistors as references. The following specifications apply using the given reference resistor over a one-minute average. The specifications assume typical laboratory conditions, which do not include transportation and large ambient temperature fluctuations.

Resistance stability is determined by the short-term stability of the internal reference resistors and control stability of the temperature stabilizing block. It does not include measurement noise.

Table 3 Resistor Stability Specifications

Resistor (Rs)	Accuracy (ppm of reading), 95 % confidence level	
	24 hours	30 days
1 Ω	5 ppm	10 ppm
10 Ω	0.5 ppm	2 ppm
25 Ω	0.25 ppm	1 ppm
100 Ω	0.2 ppm	1 ppm
10 k Ω	0.25 ppm	1 ppm

2.2.2.3 Absolute Resistance Accuracy

Absolute resistance accuracy is the ability of the instrument to measure absolute resistance, Rx, using the internal reference resistors. The following specifications apply using the given reference resistor, Rs, and excitation current.

The 1-year specifications include calibration uncertainty, reference resistor drift, ambient temperature sensitivity, resistance ratio uncertainty, and measurement noise using 1-minute average and a 2-second sample period ($n = 30$).

Performance verification is guaranteed for 99% confidence level, 1-year specifications within the specified operating temperature range of 15°C to 30°C, maintaining a calibration interval of 6 months for the first year and 1 year thereafter.

Table 4 Absolute Resistance Accuracy Specifications

Resistance range (Rs, current)	Accuracy (ppm of reading)
95% confidence level, 1-year	
0 Ω to 1.2 Ω (1 Ω , 10 mA)	Greater of 40 ppm or 0.000012 Ω
0 Ω to 12 Ω (10 Ω , 3 mA)	Greater of 10 ppm or 0.000024 Ω
0 Ω to 120 Ω (25 Ω , 1 mA)	Greater of 5 ppm or 0.000024 Ω
0 Ω to 400 Ω (100 Ω , 1 mA)	Greater of 4 ppm or 0.00008 Ω
0 Ω to 10 k Ω (10 k Ω , 10 μ A)	Greater of 5 ppm or 0.000012 k Ω
10 k Ω to 40 k Ω (10 k Ω , 10 μ A)	8 ppm
40 k Ω to 100 k Ω (10 k Ω , 2 μ A)	20 ppm
100 k Ω to 500 k Ω (10 k Ω , 1 μ A)	80 ppm
99% confidence level, 1-year	
0 Ω to 1.2 Ω (1 Ω , 10 mA)	Greater of 50 ppm or 0.000015 Ω
0 Ω to 12 Ω (10 Ω , 3 mA)	Greater of 13 ppm or 0.00003 Ω
0 Ω to 120 Ω (25 Ω , 1 mA)	Greater of 6.3 ppm or 0.00003 Ω
0 Ω to 400 Ω (100 Ω , 1 mA)	Greater of 5 ppm or 0.0001 Ω
0 k Ω to 10 k Ω (10 k Ω , 10 μ A)	Greater of 6.3 ppm or 0.000015 k Ω
10 k Ω to 40 k Ω (10 k Ω , 10 μ A)	10 ppm
40 k Ω to 100 k Ω (10 k Ω , 2 μ A)	25 ppm
100 k Ω to 500 k Ω (10 k Ω , 1 μ A)	100 ppm

2.2.2.4 Measurement Current Accuracy

Measurement current accuracy is guaranteed to meet the following specifications. The specifications are stated as percent of selected current or in absolute mA.

Table 5 Measurement Current Accuracy Specifications

Current Range	Accuracy
99% confidence level, 1-year	
0.001 mA to 0.005 mA	0.00005 mA
0.005 mA to 0.02 mA	1 %
0.02 mA to 0.2 mA	0.5 %
0.2 mA to 2 mA	0.2 %
2 mA to 20 mA	0.5 %

2.2.3 Ancillary Specifications

2.2.3.1 Temperature Measurement Noise

Temperature measurement noise indicates typical measurement noise in temperature measurements. The specifications below are given for averages taken over a period of 1 minute with a 2-second sample rate. The effect of noise may be reduced for longer averages or may be greater for shorter averages.

Noise performance is dependent upon many conditions. Some of the most important things to consider are the type of thermometer, setup, and environmental conditions such as electromagnetic interference.

Due to the subjective nature of measurement noise, it is not a guaranteed specification. The specifications listed in the table below are obtainable in a typical laboratory environment. It is important that the user make their own evaluation of measurement noise in the application and environment where the Super-Thermometer is used.

Table 6 Temperature Measurement Noise Specifications

Conditions (Rs, Current)	Standard Error of the Mean, °C
Typical performance	
25 Ω SPRT at 0°C (25 Ω, 1.0 mA)	0.00002
25 Ω SPRT at 420°C (25 Ω, 1.0 mA)	0.00006
100 Ω PRT at 0°C (100 Ω, 1.0 mA)	0.00001
100 Ω PRT at 420°C (100 Ω, 1.0 mA)	0.00003
10 kΩ Thermistor at 25°C (10 kΩ, 10 mA)	0.000003

2.2.3.2 Relative Measurement Current Accuracy

Zero-Power resistance values are calculated based on measurements taken at two levels of excitation current that differ by a factor of 1.4142. Only the portions of the errors in the currents that are uncorrelated contribute to error in the zero-power resistance value.

The following specifications may be used to estimate the contribution of current error in zero-power resistance measurements.

Table 7 Relative Measurement Current Specifications

Range	Relative Accuracy, mA
99% confidence level	
0.001 mA to 0.1 mA	0.0008
0.1 mA to 2 mA	0.003
2 mA to 20 mA	0.03

2.2.4 General Specifications

Table 8 General Specifications

Warm-up period	30 minutes
Measurement range	0 Ω to 500 k Ω
Measurement current range	0.001 mA to 20 mA
Measurement current reversal interval: Sample period of 1 second or 2 seconds Sample period of 5 second or 10 seconds	0.2 second 1.2 second
Standby current range	0.001 mA to 2 mA
AC power	100 V to 230 V (\pm 10 %) 50 or 60 Hz
Fuse Rating	2 A – T – 250 V
Specified operating temperature	15 $^{\circ}$ C to 30 $^{\circ}$ C
Absolute operating temperature	5 $^{\circ}$ C to 40 $^{\circ}$ C
Storage temperature	0 $^{\circ}$ C to 40 $^{\circ}$ C
Operating relative humidity, 5$^{\circ}$C to 30$^{\circ}$C	10 % to 70 %
Operating relative humidity, 30$^{\circ}$C to 40$^{\circ}$C	10 % to 50 %
Storage relative humidity	0 % to 95 %, non-condensing
Maximum operating altitude	3000 m
Dimensions:	
Height	147 mm (5.8 in)
Width	439 mm (17.3 in)
Depth (with handles)	447 mm (17.6 in)
Depth (without handles)	406 mm (16.0 in)
Weight	7.3 kg (16.0 lb)

2.2.5 Applying the Specifications

2.2.5.1 Introduction

The purpose of this section is to help the user apply the specifications in measurement scenarios for which the Super-Thermometer was designed. The following uncertainty calculation examples may not include all uncertainties that are present in a measurement. Be sure to follow current best practices in uncertainty analysis to correctly calculate measurement uncertainty.

2.2.5.2 How the Super-Thermometer Measures

In order to understand how to apply the specifications, it is important to know how the Super-Thermometer measures. The fundamental measurement of the Super-Thermometer is the resistance ratio. It is the ratio between an unknown resistance (R_x) and a reference resistor (R_s) – either internal or external. If a resistance measurement is needed, the ratio is multiplied by the value of the reference resistor to calculate the resistance of the R_x resistor (for more information refer to Measurement Timing in the Menus and Screens section).

If a temperature reading is required, the R_x resistance value is used to calculate the temperature using the calibration coefficients entered into the Probe Library. When ITS-90 is selected as the temperature conversion, the R_x resistance is divided by the RTPW (resistance at the triple-point of water) value that is entered in the probe definition. The resulting value is called W_{T90} . The probe calibration coefficients and the ITS-90 equations are then applied to W_{T90} to calculate the temperature reading of the probe.

Since W_{T90} is a ratio between a probe's resistance at temperature (R_{T90}) and its RTPW, W_{T90} measurement accuracy relies primarily on ratio accuracy if both R_{T90} (R_x) and RTPW are measured in close proximity in time. Also, this only applies if the RTPW was measured by the Super-Thermometer and entered into the probe definition.

When calibrating an SPRT on the ITS-90, the W_{T90} value is measured at required fixed-point temperatures. This is done by measuring the resistance of the SPRT at a fixed-point temperature followed immediately by measurement of the RTPW. This is repeated for each temperature point. Once again the ratio accuracy of the Super-Thermometer, applied to each measured resistance, determines the accuracy of the resulting W_{T90} value.

2.2.5.3 Example 1: Measuring an SPRT

This section explains how to calculate the uncertainty of a temperature measurement when measuring a calibrated 25.5 Ω SPRT at 157 $^{\circ}\text{C}$, using the internal 25 Ω reference resistor in a 1595A. Since the Super-Thermometer measurement accuracy is directly related to other sources of uncertainty, additional uncertainties will be included in the calculation for completeness.

Since an SPRT can be measured with different techniques, two different calculations will be presented to represent the most common and recommended techniques.

2.2.5.3.1 Measuring With Updated RTPW

In this example, the RTPW of the SPRT is measured by a 1595A and entered into the SPRT's probe definition in the 1595A. Then the SPRT is measured at 157 $^{\circ}\text{C}$, in temperature mode, using the coefficients entered in the SPRT probe definition.

As explained above, this measurement technique primarily uses the ratio accuracy of the Super-Thermometer. It is equivalent to measuring the ITS-90 W_{T90} value and using it to calculate temperature.

The total uncertainty of this measurement is based on six uncorrelated uncertainties. These uncertainties are:

- Resistance ratio accuracy of the 1595A at 157 $^{\circ}\text{C}$
- Measurement noise at 157 $^{\circ}\text{C}$
- Resistance ratio accuracy of the 1595A at 0.01 $^{\circ}\text{C}$ (triple-point of water)
- Measurement noise at 0.01 $^{\circ}\text{C}$
- Reference resistor drift
- Uncertainty of the triple-point of water cell

The following demonstrate how to calculate and combine the listed uncertainties.

2.2.5.3.2 Resistance Ratio Accuracy at 157 $^{\circ}\text{C}$

The resistance of the SPRT, when measuring at 157 $^{\circ}\text{C}$, is 41.1 Ω . The ratio of this resistance against the 25 Ω reference resistor is 1.644. From the resistance ratio accuracy specifications of the 1595A, the standard uncertainty ($k = 1$) when measuring a resistance ratio of 1.644 is 0.08 ppm. This is converted to temperature by dividing 0.08 ppm by 1.0×10^6 and then multiplying by 1.644. The result is then divided by W_{T90} sensitivity (dW/dT) at 157 $^{\circ}\text{C}$ which is 0.0038 (found on the SPRT calibration report, see tip below). The final result is **0.000035 $^{\circ}\text{C}$** .

2.2.5.3.3 Measurement Noise at 157 $^{\circ}\text{C}$

Random error due to measurement noise must be included as an uncertainty. During measurement at 157 $^{\circ}\text{C}$, it is observed that the standard error of the mean is **0.000040 $^{\circ}\text{C}$** .



***Note:** The user must monitor measurement noise and use the actual measured measurement noise in the uncertainty calculations.*

2.2.5.3.4 Resistance Ratio Accuracy at 0.01 $^{\circ}\text{C}$

Uncertainties related to measuring the RTPW of the SPRT must be included in the analysis. However, RTPW uncertainties are magnified when applied to uncertainties of temperatures that are above 0 $^{\circ}\text{C}$. At 157 $^{\circ}\text{C}$ this magnification is estimated by multiplying RTPW uncertainties by the W_{T90} value at 157 $^{\circ}\text{C}$ (1.612 in this example).

The resistance of the SPRT at the triple-point of water is approximately 25.5 Ω . The resistance ratio against the 25 Ω reference resistor is then about 1.02. From the resistance ratio accuracy specifications of the 1595A, the standard uncertainty due to linearity while measuring a resistance ratio of 1.02 is 0.03 ppm. This specification

is converted to temperature by dividing 0.03 ppm by 1.0×10^6 and then multiplying by 1.02. The result is then divided by W_{T90} sensitivity, dW/dT , at 0.01 °C, which is 0.004. The final result is 0.000008 °C. After multiplying by W_{T90} (1.612), the uncertainty of the RTPW resistance ratio, when applied to 157 °C, is **0.000013 °C**.

2.2.5.3.5 Measurement Noise at 0.01 °C

During measurement of the RTPW, it is observed that the standard error of the mean is 0.0000018 Ω. To convert this value into temperature, divide by the resistance sensitivity (dR/dT) of the SPRT at 0.01 °C. dR/dT at 0.01 °C is 0.1 Ω/°C (see tip below). The result is 0.000018 °C. Multiplying by W_{T90} (1.612) yields **0.000029 °C**.



Tip: Most SPRT calibration reports list the Temperature versus W values of the SPRT in a table. Typically, the dT/dW value at each temperature will be included in the same table. dR/dT can be calculated by inverting dT/dW and multiplying by the RTPW of the SPRT. Also, dW/dT can be calculated by simply inverting dT/dW .

2.2.5.3.6 Uncertainty of the TPW Cell

Uncertainty of the temperature of the triple-point of water cell must also be included. For this example, the standard uncertainty of the triple-point of water cell is 0.000050 °C. Multiplying by W_{T90} (1.612) results in **0.000081 °C**.

2.2.5.3.7 Reference Resistor Drift

Possible drift of the 25 Ω reference resistor between the TPW measurement and the 157 °C measurement must be accounted for. To reduce the possible error, both measurements should be taken in close proximity in time. For this example, the 24-hour stability specification will be used. This requires that both measurements are taken within the same 24-hour period. The standard uncertainty due to drift of the reference resistor is 0.125 ppm. This is converted to temperature by dividing 0.125 ppm by 1.0×10^6 and then multiplying by 1.612. The result is then divided by W_{T90} sensitivity (dW/dT) at 157 °C which is 0.0038. The result is **0.000053 °C**.

2.2.5.3.8 Combining the Uncertainties

At this point, all of the uncertainties can be combined by root-sum-square (RSS) since they are uncorrelated. Even though the 1595A resistance ratio accuracy is used twice in the calculation, both measurements are considered uncorrelated.

This RSS sum produces a combined standard uncertainty of **0.000115 °C**. Multiplying by the coverage factor ($k = 2$) results in a total expanded uncertainty of **0.000230 °C**.

In this example, it is assumed the SPRT did not drift between the measurements at the TPW and 157 °C. It may be necessary to add an additional uncertainty that accounts for SPRT drift.

2.2.5.3.9 Measuring With Calibration Report RTPW

In this example, the SPRT is monitored by periodically measuring its RTPW in a TPW cell but the original RTPW from the SPRT calibration report is entered in the 1595A, not the measured RTPW. This requires a different set of specifications to be used in the measurement uncertainty.

The uncertainty of this measurement is based on four uncorrelated uncertainties. These uncertainties are:

- Resistance accuracy of the 1595A when measuring the SPRT at 157 °C
- Measurement noise at 157 °C
- Uncertainty of the SPRT resistance at the triple-point of water
- Drift of the RTPW of the SPRT

2.2.5.3.10 Resistance Accuracy at 157 °C

The resistance of the SPRT at 157 °C is 41.1 Ω. Using the 25 Ω internal reference resistor, the 1595A one-year resistance standard uncertainty is 2.5 ppm. This uncertainty, in terms of temperature, is calculated by first dividing 2.5 ppm by 1.0×10^6 then multiplying by 41.1 Ω. The result is then divided by the sensitivity (dR/dT)

of the SPRT at 157 °C which is 0.1 $\Omega/^\circ\text{C}$ (see tip above). This results in a standard temperature uncertainty of **0.001028 °C**.

2.2.5.3.11 Measurement Noise at 157 °C

During measurement at 157 °C, the standard error of the mean (as reported by the 1595A) is observed to be **0.00004 °C**.

Note: The user must monitor measurement noise and use the actual measured measurement noise in the uncertainty calculations.

2.2.5.3.12 Uncertainty of the Calibration Report RTPW

In this example, the RTPW is not measured and entered into the 1595A. The RTPW from the SPRT calibration report is entered into the 1595A. The standard ($k = 1$) uncertainty of the RTPW value listed on the calibration report must be included. In this example, it is 0.0001 °C. As explained in the previous example, all uncertainties related to RTPW must be multiplied by W_{T90} of the measured temperature. Multiplying by 1.612 yields **0.000161 °C**.

2.2.5.3.13 Drift of the RTPW of the SPRT

Since an SPRT tends to drift, the long-term drift should be included as a source of uncertainty. In this example the SPRT is allowed to drift 0.002 °C. The assumed distribution of this uncertainty is rectangular. To convert to a standard uncertainty divide by 1.732 (square root of 3). The result, 0.001155 °C, multiplied by 1.612 yields a standard uncertainty of **0.001861 °C**.

2.2.5.3.14 Combining the Uncertainties

At this point, all of the uncertainties can be combined by root-sum-square (RSS) since they are uncorrelated. The RSS sum produces a combined standard uncertainty of **0.002133 °C**. Multiplying by the coverage factor ($k = 2$), and rounding, results in a total expanded uncertainty of **0.0043 °C**.

2.2.5.4 Example 2: Calibrating an SPRT

As explained in “How the Super-Thermometer Measures” at the beginning of this section, the calibration of an SPRT is performed by measuring the resistance at some required fixed-point temperature and then at the triple-point of water. The two measurements are combined by division to get a W_{T90} value. The uncertainty of W_{T90} is based primarily on the ratio accuracy of the Super-Thermometer.

In this example, an SPRT is calibrated at 419.527 °C (FP of Zinc). The RTPW is measured directly afterward. The uncertainties resulting from the 1595A in this example are:

- Resistance ratio accuracy of the 1595A at 419.527 °C
- Measurement noise at 419.527 °C
- Resistance ratio accuracy of the 1595A at 0.01°C (triple-point of water)
- Measurement noise at 0.01°C
- Reference resistor drift

The uncertainties in this example are calculated and combined as described in Example 1. However, there is a slight difference in the reference resistor drift component.

2.2.5.4.1 Reference Resistor Drift

In Example 1, the 24-hour stability specification of the internal 25 Ω is used. This may not be necessary when calibrating an SPRT. When calibrating an SPRT typically both measurements of W_{T90} are taken in close proximity of time (< 8 hours elapsed time). It is possible for the reference resistor drift to be negligible, especially if the Super-Thermometer is in a stable temperature environment.

To be sure reference resistor drift is correctly estimated, the user should perform a test to determine actual reference resistor drift over the elapsed time. One way to perform this test is to measure a very stable external reference resistor over the actual time period using the internal reference resistor. If it is not possible to measure the reference resistor drift, it may be necessary to use the 24-hour stability specification resulting in a slightly larger total uncertainty. Another alternative is to use an external reference resistor of very low drift.

2.2.5.4.2 Example 3: Measuring Zero-Power Resistance

The purpose of this example is to demonstrate how the Relative Current specification applies when performing a zero-power measurement. The zero-power uncertainty calculated in this example would be added to the rest of the uncertainties involved in the measurement as explained in previous examples. The intention of the zero-power measurement is to remove measurement errors due to self-heating of the SPRT.

In this example a 1595A is used to measure a 25 Ω SPRT at the triple-point of water using the Zero-Power function. The SPRT is measured at nominal current, 1.0 mA and 1.4142 mA (double-power current). In this example, the self-heating sensitivity of the SPRT in a triple-point of water cell is 0.0024 $^{\circ}\text{C}/\text{mA}$. This was found by using the Zero-Power function and reading the SELF-HEATING field in the Zero-Power results screen. This value will vary significantly depending on temperature, measurement medium, and probe construction.

The uncertainties used to calculate zero-power uncertainty are:

- Ratio accuracy of the 1595A
- Measurement noise
- Relative current accuracy of the 1595A
- Reference resistor stability

2.2.5.4.3 Resistance Ratio Accuracy at 0.01 $^{\circ}\text{C}$

The ratio accuracy at 0.01 $^{\circ}\text{C}$ is based on using the internal 25 Ω resistor to measure a resistance of 25.5 Ω . The 1595A standard uncertainty of resistance ratio is 0.03 ppm. To convert this value to temperature divide by 1.0×10^6 and multiply by 1.02 (Rx/Rs). The result is then divided by 0.004 (W_{T90} sensitivity, dW/dT , at 0.01 $^{\circ}\text{C}$, see above). The final result is **0.000008 $^{\circ}\text{C}$** .

2.2.5.4.4 Measurement Noise

The Zero-Power function reports the standard error of the mean of the zero-power value in the STANDARD ERROR field. In this example, the standard error of the mean is 0.0000018 Ω . To convert this value into temperature, divide by the resistance sensitivity (dR/dT) of the SPRT at 0.01 $^{\circ}\text{C}$. dR/dT at 0.01 $^{\circ}\text{C}$ is 0.1 $\Omega/^{\circ}\text{C}$ (see tip above). The result is **0.000018 $^{\circ}\text{C}$** .

2.2.5.4.5 Relative Current Accuracy

The relative measurement current specifications are listed in Table 7 of the Specifications section. The standard uncertainty of the measurement current over the range 1.0 mA to 1.4142 mA is 0.0015 mA. This is converted to temperature by multiplying by the SPRT self-heating sensitivity at 0.01 $^{\circ}\text{C}$ which is 0.0024 $^{\circ}\text{C}/\text{mA}$. The result is **0.0000036 $^{\circ}\text{C}$** .

2.2.5.4.6 Reference Resistor Stability

Since the individual measurements of the zero-power measurement are taken in close proximity in time, the drift of the reference resistor is considered negligible.

2.2.5.4.7 Combining the Uncertainties

The uncertainties of the zero-power measurement are combined by RSS with the rest of the uncertainties involved in the measurement. See the previous examples for the other uncertainties.

2.2.5.5 Example 4: Measuring a 100 Ω PRT

In this example the temperature of a typical 100 Ω PRT is measured at 420 $^{\circ}\text{C}$ with a 1595A. The uncertainties in the measurement associated with the 1595A are as follows:

- Resistance accuracy of the 1595A
- Measurement noise at 420 $^{\circ}\text{C}$

2.2.5.5.1 Resistance Accuracy at 420 $^{\circ}\text{C}$

First, calculate the 1595A absolute resistance accuracy at 257 Ω (the resistance of the 100 Ω PRT at 420 $^{\circ}\text{C}$). The one-year absolute resistance standard uncertainty ($k = 1$) of the 1594A, using the internal 100 Ω resistor, is 2.0 ppm. To convert this to an uncertainty in temperature, multiply 2.0 ppm by 1.0×10^6 then multiply by

257 Ω . Divide the result by the sensitivity of the PRT (dR/dT) at 420 °C. This can be found in the PRT calibration report. For this example, 0.4 $\Omega/^\circ\text{C}$ is used. The resulting uncertainty is **0.0013** °C.

2.2.5.5.2 Measurement Noise at 420 °C

The noise of the measurement at 420 °C is observed using the Standard Error of the Mean statistic field of the 1595A. In this example it is **0.00003** °C.

2.2.5.5.3 Combining the Uncertainties

To calculate the entire uncertainty of the measurement, the standard uncertainties from the 1595A should be combined with the ($k = 1$) PRT calibration uncertainty at 420 °C. The standard uncertainties are combined by RSS and then multiplied by the required coverage factor.

2.2.5.6 Example 5: Measuring a 10 k Ω Thermistor

In this example, a 1595A is used to measure a 10 k Ω thermistor probe at 0 °C. The 1595A accuracy, when measuring the thermistor probe is based on the following:

- Resistance accuracy of the 1595A
- Measurement noise

2.2.5.6.1 Resistance Accuracy

First, calculate the 1595A absolute resistance accuracy at 26839.94 (the resistance of the 10-k Ω thermistor probe at 0 °C) when using the 10 k Ω internal reference resistor. The one-year absolute resistance accuracy is 4 ppm of reading ($k = 1$). This is converted to temperature by dividing 4 ppm by 1.0×10^6 and multiplying by 26839.94 Ω . The result is then divided by dR/dt of the thermistor probe at 0 °C which, in this example, is 1244.9 $\Omega/^\circ\text{C}$. The final result is **0.000085** °C.

2.2.5.6.2 Measurement Noise

Measurement noise is best observed by using the Standard Error of the Mean statistics field of the Super-Thermometer. In this example, the standard error of the mean is **0.000004** °C.

2.2.5.6.3 Combining the Uncertainties

If the thermistor probe is being measured in temperature mode with calibration coefficients, the standard uncertainty of the calibration (listed on the calibration report) would be combined by RSS with the resistance accuracy and measurement noise uncertainties.

3 Preparation for Operation

3.1 Unpacking and Inspection

The Super-Thermometer is shipped in a container designed to prevent damage during shipping. Inspect the contents of the container for damage and immediately report any damage to the shipping company. Instructions for inspection are included in the shipping container.

Table 9 Optional Accessories

Item	Model or part number
Rack Mount Kit	1594-RMKT
2590 Scanner	2590
Case	1594-CASE
Carry-handle Kit	1594-HNDL
Extended range test report	1994 (1594A), 1995 (1595A)

3.2 Instruction Manuals

The Super-Thermometer instruction manual set is shipped on DVD. The set includes:

- 1594A/1595A Super-Thermometer User's Guide
- 1594A/1595A Super-Thermometer Technical Guide

The 1594A/1595A Super-Thermometer User's Guide contains instructions for unpacking and setting up the instrument. Specifications and an overview of Super-Thermometer operation are also included. The User's Guide is available in the following languages: English, Chinese, Spanish, Japanese, German, French, and Russian.

The 1594A/1595A Super-Thermometer Technical Guide contains complete information for setting up and operating the Super-Thermometer. It also includes instructions for remote operation, calibration and maintenance. The Technical Guide is available in English only.

For ordering a replacement instruction manual DVD contact your local Fluke representative or service center. All manuals are available online for download in PDF format.

3.3 Line Voltage and Fuses



CAUTION: To prevent possible damage to the instrument, verify the correct fuse is installed for the selected line voltage setting.

The correct line power fuse and line voltage range was installed at the factory per the configuration that was ordered. However, it is important to verify the correct fuse value and line voltage setting. The fuse is accessible on the rear panel in the PEM (Power Entry Module). The line voltage setting is shown in the PEM window (see Figure 1 on page 16) and see Section 2.2, Specifications, on page 5 for the fuse rating.

To check or replace the fuse and to verify or change the line voltage setting, refer to Figure 1 on page 16 and proceed as follows:

1. Disconnect line power.
2. Observe what line voltage setting is displayed in the PEM window. If it is correct, the fuse assembly will be re-inserted in the same orientation it is removed. Otherwise, it will need to be rotated 180° before re-insertion.
3. Open the fuse compartment by inserting a screwdriver blade in the slot located at the top of the fuse compartment and open the PEM door.
4. Use the screwdriver blade to pry out the fuse block by inserting the blade in the slot located at the top of the fuse block.
5. Remove the fuses from the assembly for replacement or verification. Be sure the correct fuses are installed.
6. Reinstall the fuse assembly by pushing it back into the PEM while ensuring that the correct line voltage label is shown in the PEM window. Close the PEM door so it locks in place.

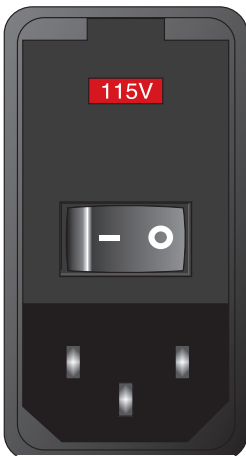

Figure 1 PEM (Power Entry Module)

3.4 Connecting to Line Power



WARNING: To avoid electrical shock, connect the factory supplied three-prong line power cord to a properly grounded power outlet. Do not use a two-prong adapter or extension cord that will break the ground connection.

After the line voltage setting and correct fuse are verified, connect the instrument to a properly grounded three-prong outlet using the provided line voltage cord.

3.5 Placement and Rack Mounting

In general, place the Super-Thermometer in an area free of drafts and excessive electrical noise. Refer to the specifications for environmental requirements.

The Super-Thermometer is designed to be used on a bench-top or installed in a standard width rack with the optional rack mount kit. For bench-top use it is equipped with hinged, non-slip feet. For rack mount instructions, refer to the rack mount kit instruction manual.

4 Front and Rear Panel Features

4.1 Introduction

The Super-Thermometer has been designed with several features that help make setup and operation as simple as possible while still providing many measurement capabilities. This section describes the front and rear panel features as well as the menu system. Please read this section before operating the instrument.

4.2 Front Panel Features

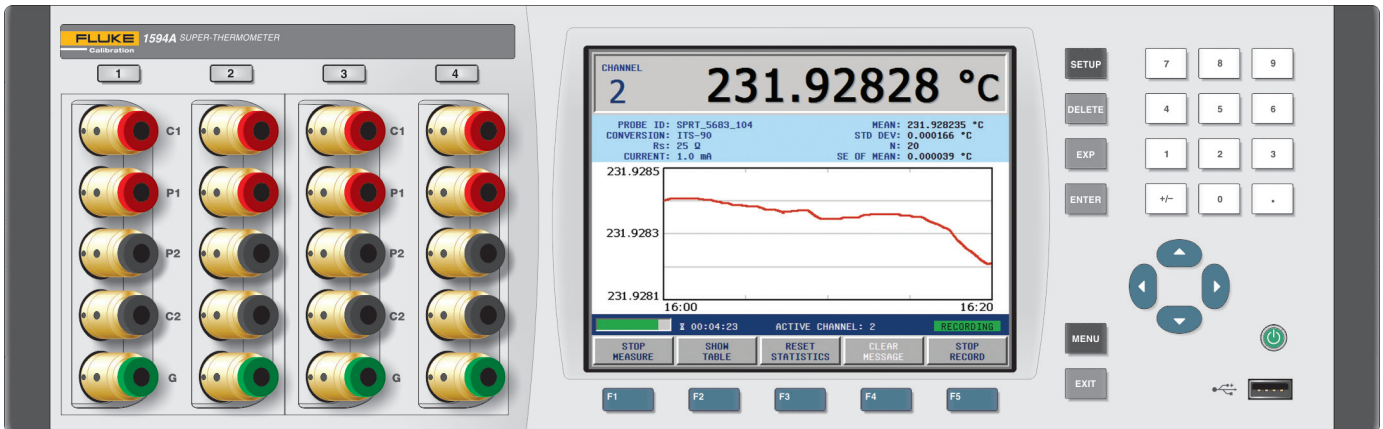

Figure 2 Front view

4.2.1 Measurement Inputs

Four measurement inputs, channels 1 through 4, are located on the front panel. Some key points concerning the measurement inputs are:

- Current (C1, C2), Potential (P1, P2), and Guard (G) terminals are labeled to facilitate correct connection (Figure 16 on page 58).
- Channels 2 and 4 can also be used as reference resistor (Rs) inputs.

4.2.2 USB Connection









The USB port on the front panel allows a formatted USB memory device to be connected to the Super-Thermometer for saving measurements and settings. The memory device must be Linux compatible and formatted with the FAT32 file system.

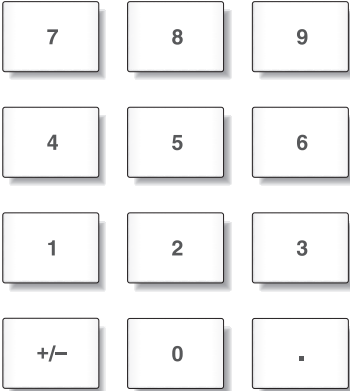
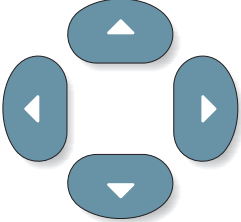

Important: When inserting a USB memory device into the front panel USB port, wait for about 10 seconds to allow the system to recognize the memory device before attempting to write to or read from it.

4.2.3 Front Panel Keys

Table 10 Front panel key descriptions

	<p>The Power Standby key turns off the display and disables the front panel keys, sending the system into standby. Power remains applied to some internal components such as the resistor oven.</p> <p>When the system is brought out of standby by pressing the Power Standby Key, it is not necessary to wait the 30-minute warm-up period.</p>
	<p>The numeric keys consist of the digits 0 through 9, sign (+/-), and decimal point (.). These keys are used for entering numeric values.</p>
	<p>The arrow keys are used to move the cursor on the display and to navigate lists</p>
	<p>The SETUP key is used to directly access the Channel Setup menu for quick and easy measurement configuration.</p>
	<p>The DELETE key is used to delete alpha-numeric characters</p>
	<p>The EXP key is used when entering an exponential number for example: 1.0 E-04</p>
	<p>The ENTER key is used to save a change or to select an item. When an item is changed, ENTER must be pressed otherwise the item reverts to its original value upon exiting.</p>
	<p>The MENU key is used to go directly to the Main Menu screen.</p>
	<p>The EXIT key is used to exit from a menu or setting. Pressing EXIT will leave an edit without saving the changes. When entering a number, if EXIT is pressed and held, the entire number is deleted and the cursor is moved to the leftmost place in the number field.</p>
	<p>The Function Keys are located below the display and are used to execute the function displayed directly above them. Function keys are used to select menu options and in certain cases they are used to toggle a setting shown on the display.</p>
	<p>Pressing any of the four Channel Select Keys will automatically activate the selected channel and illuminate the Channel Select Key in green. If a channel is in standby mode, the Channel Select Key is illuminated in amber. If a channel is inactive, the Channel Select Key is clear.</p>

4.2.3.1 Front Panel Display

The Front Panel Display is shown in Figure 3. The display screen is used to show all measurements, menus and configuration information.

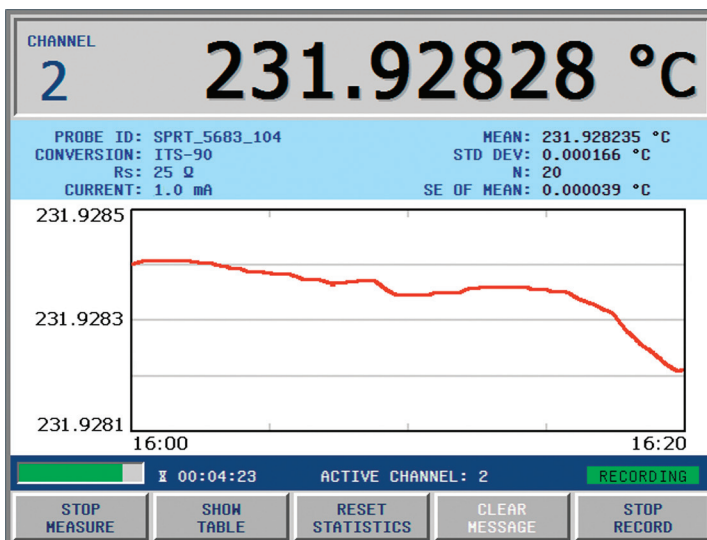

Figure 3 Front Panel Display

The default display language is English. The display can be shown in the following language options: English, Chinese, Spanish, Japanese, German, French, and Russian.

The display language can be changed in the User Settings screen. The User settings screen is displayed, in English (regardless of language setting), when using a shortcut key sequence that is entered from the Measurement screen. In the Measurement screen (press and hold the EXIT key to return to the Measurement screen), press and release the ENTER key and then press the SETUP key. Use the Up/Down arrow keys to select the LANGUAGE configuration field and then use the Left/Right arrow keys to choose the intended language. Pressing the ENTER key saves the new selection.

For all other display configuration settings, see Section 5.7.4, DISPLAY MENU (F4), on page 46.

4.3 Rear Panel Features

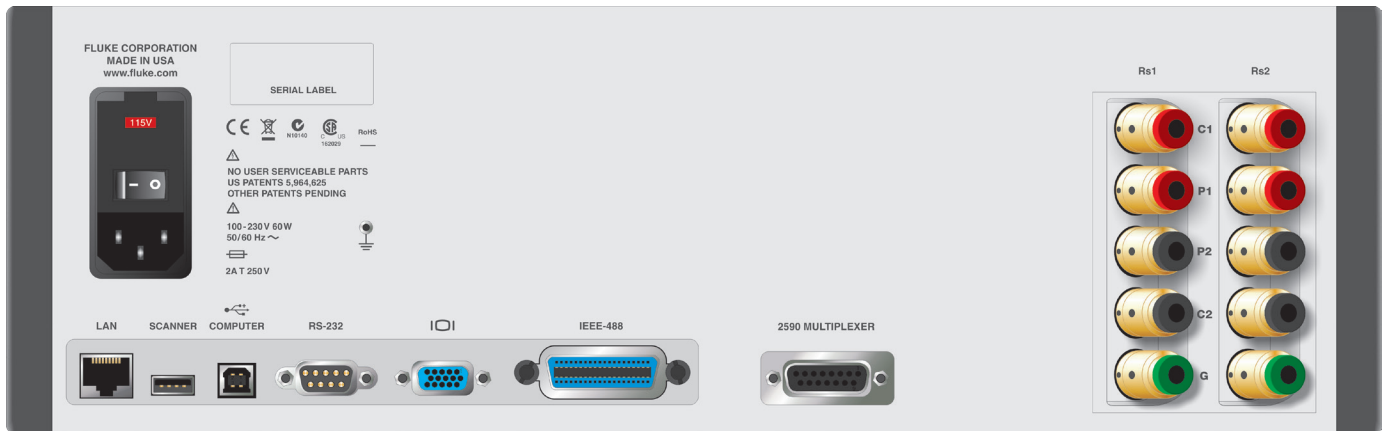

Figure 4 Rear view

4.3.3.1 External Resistor Inputs

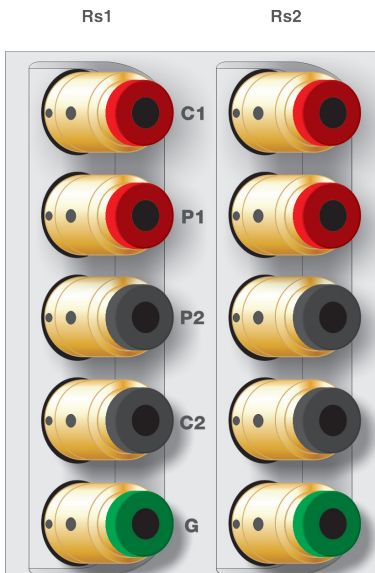

Figure 5 External Resistor Inputs

The Rs1 and Rs2 external reference resistor connections are located on the rear panel. The Current (C1, C2), Potential (P1, P2) and Guard (G) terminals are labeled to facilitate proper connection (see Figure 16 on page 58).

4.3.1 Scanner Connection



The 2590 Scanner connection is a 15-pin socket located on the back panel. It is used to control an optional scanner. Refer to the scanner manual for connection and setup instructions.

4.3.2 Future Peripheral Connection

SCANNER



A USB peripheral port is intended for future peripheral control.







Note: This port is NOT used for external memory connection. For external memory via USB see Section 4.2.2, USB Connection, on page 17 and Figure 2 on page 17.

4.3.3 Remote Operation Connections

The Super-Thermometer comes equipped with several remote operation connections. See Table 11 for the remote operation connection descriptions.

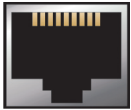
Using the LAN connection and a web browser, the user is able to operate the Super-Thermometer remotely via the provided web interface. The Super-Thermometer serves a page that allows the user to view the display and control the Super-Thermometer through the web browser. For more information, refer to the Remote Operation section.

Table 11 Remote Operation Connections

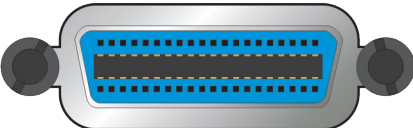
Connection	Description
<p>LAN</p> 	Ethernet connector that allows connection to a network for controlling the instrument and transmitting measurements
<p>COMPUTER</p>  	USB port that allows the instrument to be controlled as a USB peripheral from a computer
<p>RS-232</p> 	9-pin subminiature D type serial port that can be used to control the instrument via RS-232
<p>IEEE-488</p> 	IEEE-488 Input/Output that is compatible with IEEE-488 interface and the IEC 625 Bus for controlling the instrument

4.3.4 Line Voltage Connection



Figure 6 Power Entry Module

The PEM (Power Entry Module) located on the rear panel connects the Super-Thermometer to line voltage. It contains the Line Voltage Power Switch, the Line Voltage Fuses, and the Line Voltage Selector. See the Line Voltage and Fuses section for configuration and connection instructions.

4.3.5 Earth Ground Connection



The Earth Ground Connection is provided to allow connection to earth ground. This connection can help improve measurement noise. It is not intended to replace the ground connection provided through the line voltage cord.

5 Menus and Screens

5.1 Introduction

This section provides detailed description of the Super-Thermometer menus and screens. The menus and screens are designed to allow the user to quickly and easily set up the instrument for measurement while also providing many configuration options. Note that some function keys are located in multiple locations in the menu system for convenience.

Since the Super-Thermometer menu system is several layers deep, this section uses a location descriptor at the introduction of menu function keys. This helps the user identify where the function key resides in the menu system. Below is a location descriptor example.

MAIN MENU | CHANNEL SETUP | CHANNEL SETTINGS

Figure 7 Location Descriptor Example

5.2 Changing Settings

Most screens within the menu system contain configuration fields used for changing settings. Whenever a configuration field is changed the ENTER key must be pressed to save and apply the new value. To change a setting, the field must be highlighted. The highlight can be moved through the fields using the Up/Down arrow keys.

Configuration fields that have selection options are changed by pressing the Left/Right arrow keys to the desired setting and pressing ENTER.

Numeric type fields are used for setting numeric settings, which include probe coefficients, time, and date, for example. Values are set using the digit keys. The left and right arrow keys move among the digits to change a digit in the number. The sign key and EXP key are necessary for signed and exponential values. The DEL key may be used to delete a digit in the number. ENTER must be pressed to save a new value.

Some configuration fields allow entry of alpha and numeric characters. For these fields, the Alpha-Numeric Interface is used. It automatically opens by pressing the ENTER key when a text field is highlighted.

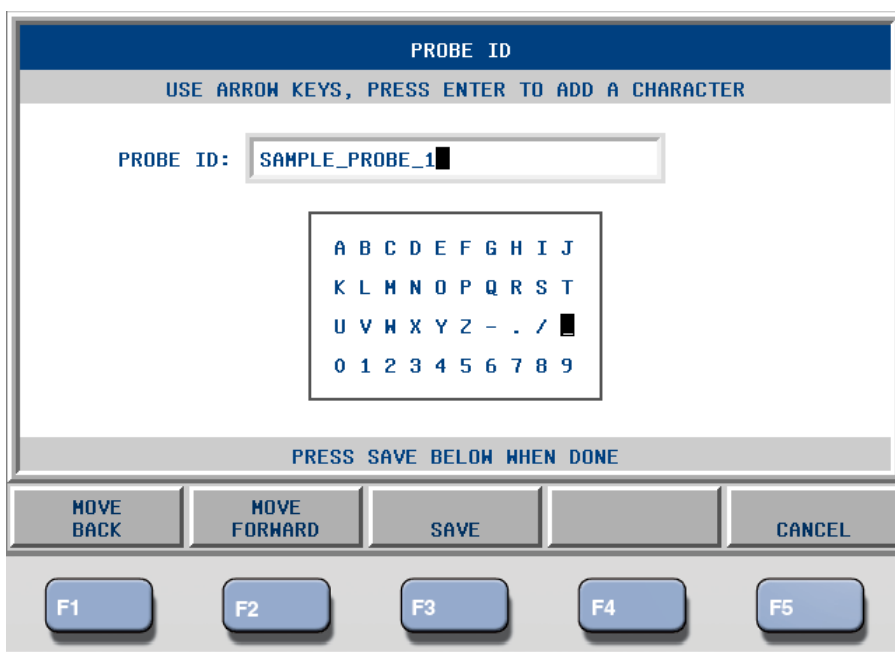

Figure 8 Alpha-Numeric Interface

In the Alpha-Numeric Interface, use the front panel arrow keys to move the cursor to the desired character. Press the ENTER key to enter the selected character in the text edit box. Numeric characters can be entered using the Alpha-Numeric Interface or the front panel digit keys.

If a mistake is made, pressing the DELETE key will backspace over the character to the left of the cursor. When the cursor is placed over a character in the text edit box, the DELETE key will delete the character where it is located.

Use function keys MOVE BACK (F1) and MOVE FORWARD (F2) to move the cursor left or right in the text edit box. Use function keys SAVE (F3) and CANCEL (F5) to save or cancel the changes that have been made to the text field. The EXIT key will also exit the Alpha-Numeric Interface with no changes saved.

5.3 Password Protection

Some screens by default are password protected while others may be password protected depending on configuration settings. A screen that is password protected will open with edit ability only if a four-digit password is entered. Otherwise, the screen will open with view only. (see Section 5.7.7.1, PASSWORD (F4), on page 54).

5.4 Menu Navigation

The following are important items to help the user understand how to navigate the menu system:

- The Main Menu of the menu system may be accessed from the Measurement Screen (and most other screens) by pressing the MENU key.
- Function Keys (F1, F2, F3, F4, F5) are used to select menus, functions, and in some cases, to toggle settings.
- The EXIT key is used to exit a screen or menu and return to the parent screen. In most screens, pressing and holding the EXIT key for a moment returns directly to the Measurement Screen.
- Menus and screens contain help text that clarify the purpose of the menu or screen.
- When any setting is changed in a screen, the ENTER key must be pressed to save the change.
- When a field requires alpha-numeric character input, the Alpha-Numeric Interface opens automatically upon pressing ENTER when the field is highlighted.
- Some screens may be password protected. If the password is required, a special password screen will appear. More information concerning password protection is found in the System Menu section.
- The SETUP key provides a shortcut to the Channel Setup screen, Section 5.7.1, CHANNEL SETUP (F1), on page 29.
- Pressing ENTER, then SETUP provides a shortcut to the User Settings screen, Section 5.7.4.1, USER SETTINGS (F1), on page 47, where the language setting and other user settings are located.
- The User Settings screen will appear as the initial screen if the Start-Up Help setting is enabled (see Section 5.7.4.1, USER SETTINGS (F1), on page 47). This assists a first-time user in setting preferences and the system clock.

5.5 Menu System

The following is an outline of the menu system:

```
Measurement Screen
|
MAIN MENU (MENU key)
  CHANNEL SETUP (SETUP key)
  |   ASSIGN PROBE (see PROBE MENU below)
  |   CHANNEL SETTINGS
  |   |   SET UP Rs
  |   |   |   ASSIGN RESISTOR
  |   |   |   DEFINE RESISTOR
  |   |   |   |   ADD RESISTOR
  |   |   |   |   EDIT RESISTOR
```

```
| | | READ RESISTOR
| | | MANAGE RESISTORS
| | | READ FILE
| | | WRITE FILE
| | | MOVE UP
| | | MOVE DOWN
| | | DELETE RESISTOR
| | ON/OFF
| | MEASURE MENU (see MEASURE MENU below)
PROBE MENU
| ADD PROBE
| COPY PROBE
| EDIT PROBE
| | TEST CALCULATION
| READ PROBE
| MANAGE PROBES
| | READ FILE
| | WRITE FILE
| | MOVE UP
| | MOVE DOWN
| | DELETE PROBE
MEASURE MENU
| SCAN SETTINGS
| TIMING SETTINGS
| DIGITAL FILTER
| | CLEAR FILTER
| RECORDING MENU
| | RECORDING SETTINGS
| | VIEW DATA
| | READ FILE
| | WRITE FILE
| | ERASE DATA
| ZERO-POWER MEASUREMENT
DISPLAY MENU
| USER SETTINGS
| FIELD SETTINGS
| STATISTICS SETTINGS
| GRAPH SETTINGS
| TEMPERATURE UNIT
SYSTEM MENU
| TIME DATE
| REMOTE INTERFACE
| | SERIAL
| | USB
| | NETWORK
| | IEEE-488
| | ERRORS
| CONFIG
| | STORE CONFIG
| | RECALL CONFIG
| | DELETE CONFIG
| | RESTORE DEFAULT
| | UPDATE FIRMWARE
| PASSWORD
| CALIBRATION
| | SYSTEM TEST
| | CURRENT TEST
| | RATIO CALIBRATION
| | RESISTANCE CALIBRATION
| | CALIBRATION PARAMETERS
```

5.6 Measurement Screen

The Measurement Screen contains the function keys and display fields needed for typical measurement operation. It is the screen displayed after power-up unless the Start-Up Help setting is enabled (see Section 5.7.4.1, USER SETTINGS (F1), on page 47). It may be recalled other screens by pressing and holding the EXIT key

or by pressing and releasing the MENU key then pressing the EXIT key. The following describe each section of the Measurement Screen.

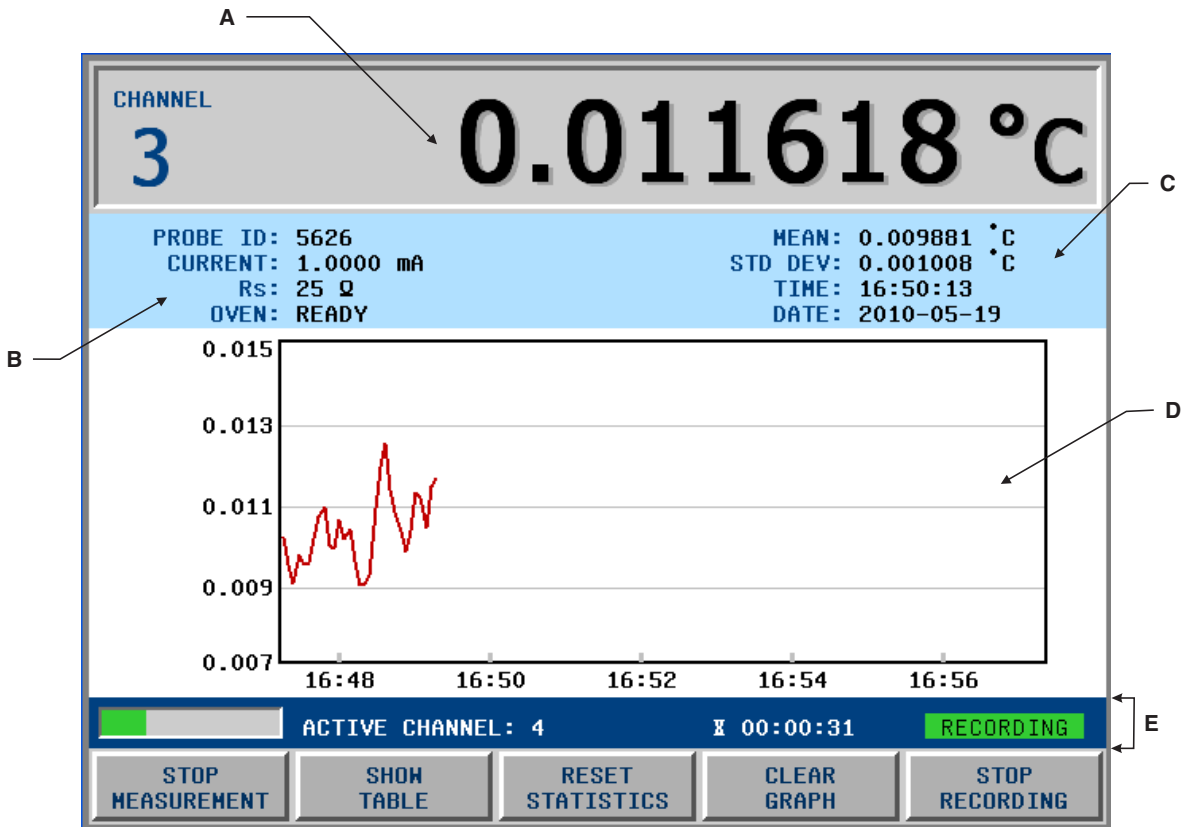

Figure 9 Measurement Screen

The following are the different sections of the Measurement Screen (see Figure 9) followed by detailed descriptions of each section:

- A. Channel Measurement Display
- B. Channel Summary Section
- C. Statistics Fields
- D. Data/Graph Section
- E. Status and Alert Section

5.6.1 Channel Measurement Display

The Channel Measurement Display is located at the top of the screen and shows the most recently completed measurement and the channel from where the measurement came. This portion of the screen is always visible, even when other screens and menus are open.

5.6.2 Channel Summary Section

The Channel Summary Section, directly below the Channel Measurement Display, on the left, shows channel configuration information with the following four fields.

PROBE ID – shows the identification of the probe definition assigned to the channel being measured (see Section 5.7.2, PROBE MENU (F2), on page 34)

CURRENT – shows the excitation current used in measuring the probe (see Sensing Current under Section 5.7.1.2, CHANNEL SETTINGS (F2), on page 30)

RS – shows the reference resistor used for the measurement (see Section 5.7.1.2, CHANNEL SETTINGS (F2), on page 30).

OVEN - indicates whether the resistor oven is stable and ready for measurement. After power up, the OVEN field will first indicate “SETTLING” while the oven warms up and settles to the proper temperature. When the oven temperature is stable, the field will display “READY” to indicate that the Super-Thermometer is ready for measurement. It typically takes about 30 minutes for the temperature to settle and the indication to change to “READY.” If only external reference resistors are used, it is not necessary to wait for the oven to settle.

5.6.3 Statistics Fields

The Statistics Fields section of the display contains user-selectable statistics fields associated with the currently displayed measurement (see Section 5.7.4.2, FIELD SETTINGS (F2), on page 48)

The Statistics Fields are displayed during measurement regardless whether Graph or Data display mode is selected. The fields are reset when the RESET STATISTICS (F3) function key is selected.

5.6.4 Data/Graph Section

The Data/Graph section displays either a data table for each active channel as it is measured or a graph of each channel’s measurement trend. The display is toggled from Data to Graph mode by pressing the SHOW DATA/ GRAPH (F2) function.

When the data table is selected, the Up/Down arrow keys are used to scroll through the data table to view channels off the screen. The data fields are reset when the RESET STATISTICS (F3) function key is selected.

The graph settings are configured in the Graph Settings Screen, see Section 5.7.4.4, GRAPH SETTINGS (F4), on page 49. The graph window can be configured to display a separate graph for each channel or all channels on one graph.

5.6.5 Status and Alert Section

The Status and Alert section resides at the bottom of the display above the function keys. Depending on the situation, the following are displayed in the Status and Alert section:

Measurement Progress Bar- indicates the progress of the current measurement

Countdown Timer- shows the time remaining before measurement stops. The timer is set in the Timing Settings screen of the Measure menu see Section 5.7.3.2, TIMING SETTINGS (F2), on page 39. If measurement is stopped and restarted, the timer starts over again.

Active Channel- indicates the channel currently being measured. When the measurement is completed, the measurement value and channel number will appear in the channel measurement display.

Recording Status- indicates whether recording is in progress.

Alert Messages- displays alert messages. Alert messages only appear when the Measurement Screen is displayed. See the following table for a list of alert messages. When an alert message is displayed, the CLEAR MESSAGE (F4) function key may be pressed to clear the message.

Table 12 Alert Messages

Priority	Message	Description
1	RECORDING ERROR	A recording error occurred, such as memory full or USB device was removed, that prevents further recording.
2	MAXIMUM TEMPERATURE EXCEEDED	The measured temperature exceeds the Maximum Temperature setting specified in the probe definition.
3	ITS-90 SUBRANGE EXCEEDED	The measured temperature is outside either of the selected ITS-90 subranges in the probe definition.
4	RESISTOR DUE FOR CALIBRATION	The Rs resistor used for the measurement is due for calibration; as specified by the Due Date setting in the resistor definition.

The following function keys are located in the Measurement screen:

5.6.6 START/STOP MEASUREMENT (F1)

The Start/Stop Measurement function key is a toggling function key that starts and stops measurement sampling.

5.6.7 SHOW TABLE/GRAPH (F2)

The Show Table/Graph function key toggles the display between Graph mode and Data mode.

5.6.8 RESET STATISTICS (F3)

The Reset Statistics function key resets all statistics fields and sample counts.

5.6.9 CLEAR GRAPH/CLEAR MESSAGE (F4)

The Clear Graph/Clear Message function key clears the measurement trend graph. When an alert message is displayed, this function key changes to Clear Message, which may be used to clear the alert message.

5.6.10 START/STOP RECORD (F5)

The Start/Stop Record function key is a toggling function key that starts and stops recording of measurements to memory (see Section 5.7.3.4, RECORDING MENU (F4), on page 41).

5.7 Main Menu

The Main Menu is accessed by pressing the MENU key. The Main Menu contains the submenus used for Super-Thermometer configuration and setup.

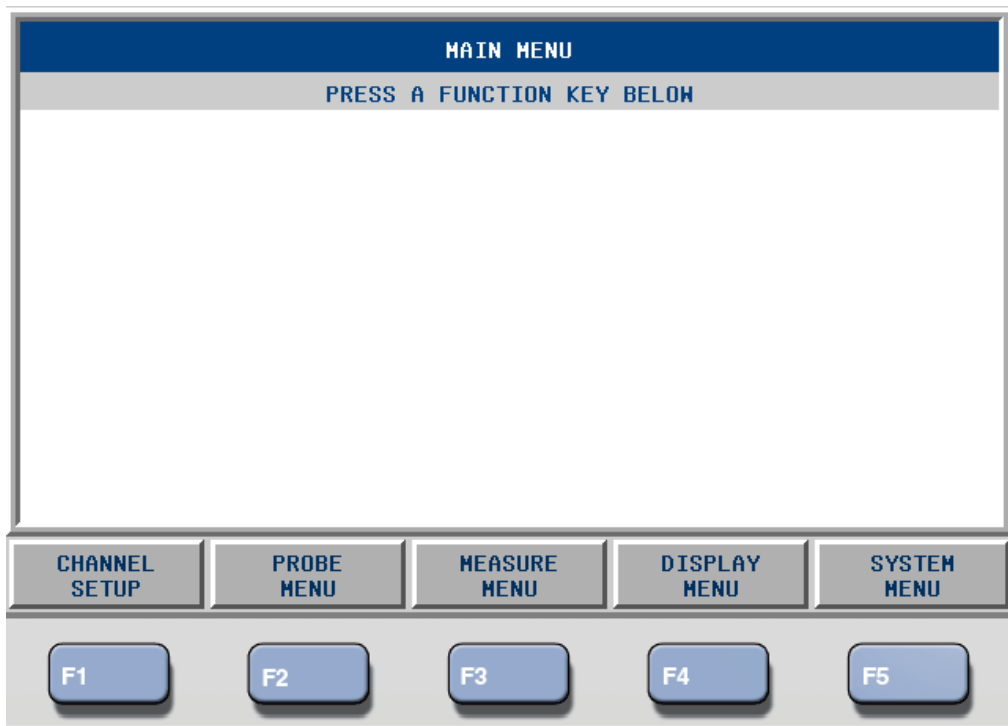

Figure 6- Main Menu Screen

The submenus located in the Main Menu screen are as follows:

CHANNEL SETUP - for configuring measurement channels and reference resistor settings

PROBE MENU - for assigning probe definitions to measurement channels and managing the Probe Library

MEASURE MENU - for configuring channel scanning, setting measurement timing, configuring the digital filter and turning recording on and off

DISPLAY MENU - used to configure display settings, and statistics settings as well as selecting temperature measurement units

SYSTEM MENU - used to configure the remote interface ports, set the system date and time, configure password settings and calibrate the Super-Thermometer

The following are detailed descriptions of each submenu and its contents.

5.7.1 CHANNEL SETUP (F1)

MAIN MENU |

The Channel Setup menu is used for configuring measurement channels and reference resistor settings. The Channel Setup screen shows each channel and its settings. Pressing the SETUP key on the front panel will access the Channel Setup screen directly from any other screen or menu.

For convenience, the MEASURE MENU (F4) function key is included in this menu as well as the Main Menu. The Measure Menu is described in full detail after the Probe Menu section.

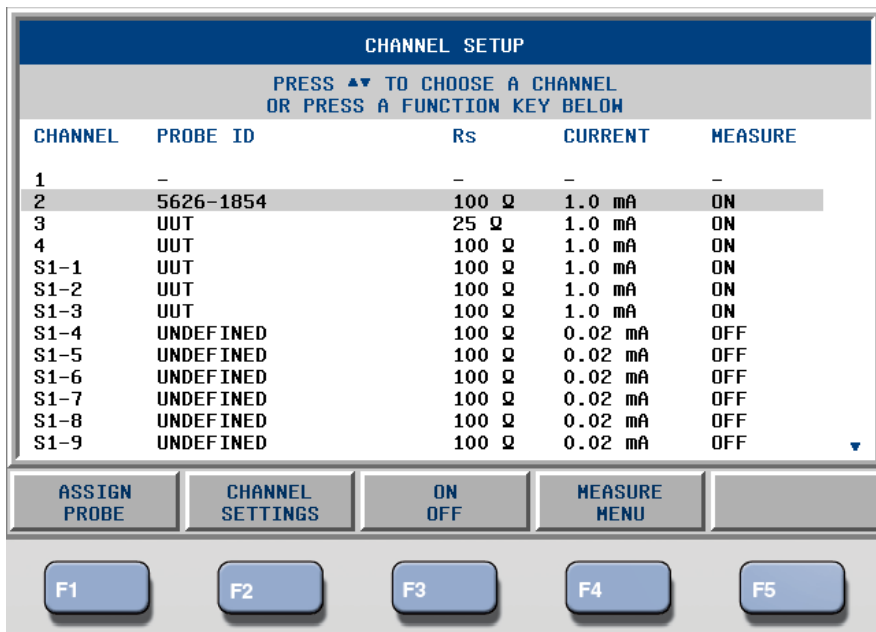

Figure 10 Channel Setup Screen

Using the Up/Down arrow keys, the user selects the channel to be configured. Pressing the ON/OFF (F3) function key enables (ON) or disables (OFF) the selected channel. Only one channel can be enabled unless SCAN ENABLE is set to ON (see Section 5.7.3.1, SCAN SETTINGS (F1), on page 39). A channel that is disabled will be skipped when SCAN ENABLE is set to ON. A channel can also be enabled by pressing the corresponding Channel Select Key on the front panel.

The following function keys are used to configure the channels.

5.7.1.1 ASSIGN PROBE (F1)

MAIN MENU | CHANNEL SETUP |

The Assign Probe function key allows the user to assign a predefined probe definition to the selected channel.

Upon pressing the Assign Probe function key, the Probe Library is displayed. Using the Up/Down arrow keys, the desired probe definition is highlighted. Pressing ENTER assigns the probe definition to the previously selected channel. For convenience, the function keys needed for editing the Probe Library are included in the Assign Probe screen. These function keys are described in detail in the Probe Menu section.

5.7.1.2 CHANNEL SETTINGS (F2)

MAIN MENU | CHANNEL SETUP |

With the desired channel selected in the Channel Setup screen, pressing the Channel Settings function key opens a screen that allows the user to configure the channel settings. The channel that is being configured is identified at the top of the Channel Settings screen.

The channel configuration fields are as follows:

REFERENCE RESISTOR (Rs) - identifies the reference resistor to be used for measurement. The options are any of the four internal resistors (1Ω, 10Ω, 25Ω, 100Ω, 10 kΩ) and any user-configured external resistor. See Table 13 for the recommended reference resistor.

Table 13 Recommended Reference Resistor for Various Probe Types

Probe Type	Reference Resistance	Sensing Current
25 Ω SPRT	25 Ω	1.0 mA
100 Ω PRT or RTD	100 Ω	1.0 mA
2.5 Ω SPRT	10 Ω	5.0 mA
0.25 Ω SPRT	1 Ω	14.14 mA
1000 Ω PRT or RTD	10 kΩ	0.05 mA
Thermistors, 2 kΩ to 20 kΩ	10 kΩ	0.01 mA
Thermistors, 20 kΩ to 100 kΩ	10 kΩ	0.002 mA

SENSING CURRENT - the excitation current used for measurement. By default, it is set to the nominal current value entered in the probe's definition. However, if the user enters a different sensing current, the new value will supersede the probe definition.

The **1 x POWER (F2)** function key automatically sets Sensing Current to the Nominal Current value established in the probe definition. **2 x POWER (F3)** sets Sensing Current to 1.4142 times the nominal current. In order to protect the device being measured, the current is limited by the Maximum Current setting in the probe definition.

STANDBY CURRENT- allows current to pass through a probe or resistor even when it is not being actively measured. This is useful for keeping the probe self-heated so it will need less time to settle when measured. The magnitude of the standby current is the same as the Sensing Current as long as the Sensing Current is no greater than 2 mA. If the Sensing Current is greater than 2 mA, the channel's standby current will remain off regardless of the Standby Current setting.



Important: All currents are switched off when Measurement is stopped. Also, when Scan Enable is on (see Scan Enable in Section 5.7.3.1, SCAN SETTINGS (F1), on page 39), only those channels that are enabled for measurement will have standby current on, depending on the Sensing Current and Standby Current settings.



Tip: A probe's sensing element is heated as current passes through it. This effect is called self-heating. Self-heating causes a probe's measured temperature to change slightly due to the heat being dissipated. The measurement error associated with self-heating depends on probe design and the level of measurement current. To measure the effect of self-heating, use the Zero-Power function in the Measure Menu, see Section 5.7.3.5, ZERO-POWER MEASUREMENT (F5), on page 43 .

CALCULATION - determines the type of reading the channel measurement will display. The options are RESISTANCE, RATIO and TEMPERATURE. The TEMPERATURE option is available only if a probe definition, configured for temperature measurement, has been assigned to the channel (see Section 5.7.2, PROBE MENU (F2), on page 34). The Resistance option is not available if the channel's Reference Resistor (Rs) setting is set to Variable Resistance.

5.7.1.2.1 SET UP Rs (F1)

MAIN MENU | CHANNEL SETUP | CHANNEL SETTINGS |

Pressing the Set Up Rs function key displays the Rs definition assigned to each Rs input. The Up/Down arrow keys are used to scroll through the list to select an Rs input for configuration. The following function keys allow the user to configure the Rs input.

5.7.1.2.1.1 ASSIGN RESISTOR (F1)

MAIN MENU | CHANNEL SETUP | CHANNEL SETTINGS | SET UP Rs |

The Assign Resistor function key opens the resistor definition library. This is a list of Rs configurations that have been created by the user. The resistor definition library may contain up to 50 resistor definitions. Every definition in the library must have a unique ID.

Also displayed in the resistor definition library, at the end of the list, are factory default options VARIABLE RESISTANCE and NO RESISTOR.

The VARIABLE RESISTANCE option is used when the Rs resistance will vary such as when a SPRT is being used as a reference resistor. When in this mode, measurement output will be in ratio only.

If the NO RESISTOR option is chosen, the Rs Input cannot be used as a reference resistor connection.

5.7.1.2.1.1.1 DEFINE RESISTOR (F2)

MAIN MENU | CHANNEL SETUP | CHANNEL SETTINGS | SET UP Rs |

The Define Resistor function key displays the resistor definition library. The displayed function keys are used to create new Rs resistor definitions or edit definitions stored in the resistor definition library. The following describe each function key.

5.7.1.2.1.1.2 ADD RESISTOR (F1)

MAIN MENU | CHANNEL SETUP | CHANNEL SETTINGS | SET UP Rs | DEFINE RESISTOR |

The Add Resistor screen is used to create a new Rs definition using the following configuration fields and function key.

RESISTOR ID - used to identify the reference resistor. Pressing the ENTER key while the RESISTOR ID field is highlighted will open the Alpha-Numeric Interface to allow entry of a unique ID.

RESISTANCE VALUE - the resistance value of the Rs reference resistor. This resistance value is used to calculate UUT resistance so it is important that it is entered correctly.

MAXIMUM CURRENT - establishes the maximum current allowed to be applied during measurement. This prevents excessive current from being applied to the reference resistor.

CALIBRATION DATE - used to define when the reference resistor was calibrated. If not used, the digits can all be set to zeros.

DUE DATE - used to alert the user when the reference resistor is due for calibration. This is only applicable if Rs DUE ALERT is enabled in the User Settings screen, see Section 5.7.4.1, USER SETTINGS (F1), on page 47.

SAVE (F1)

The Save function key saves the settings.

CANCEL (F5)

The Cancel function key exits Add Resistor without saving changes.

5.7.1.2.1.3 EDIT RESISTOR (F2)

MAIN MENU | CHANNEL SETUP | CHANNEL SETTINGS | SET UP R_s | DEFINE RESISTOR |

The Edit Resistor function key opens the highlighted R_s definition for editing. The configuration fields are explained in the Add Resistor section above.

5.7.1.2.1.2 READ RESISTOR (F3)

MAIN MENU | CHANNEL SETUP | CHANNEL SETTINGS | SET UP R_s | DEFINE RESISTOR |

Read Resistor allows the user to load a pre-configured reference resistor definition from a USB memory device.

To load a resistor definition, insert a USB memory device that contains a resistor configuration into the front panel. Allow about 10 seconds for the system to recognize the USB device and then press OK (F5). A list of resistor definition files stored on the memory device appears on the screen. Scroll through the list using the Up/Down arrow keys and select the file to be loaded. Press OK (F5) to begin the file transfer. A message will prompt the user to continue.



Tip: Resistor definition files must be located in a folder named “\159x\resistor” on the USB memory device. The files must have the extension “.res” and contain resistor definition data in the proper format. This type of file can be created by using the Write File function, see Section 5.7.1.2.1.3.2, WRITE FILE (F2), on page 32 in the Manage Resistors menu.

5.7.1.2.1.3 MANAGE RESISTORS (F3)

MAIN MENU | CHANNEL SETUP | CHANNEL SETTINGS | SET UP R_s |

R_s resistor definitions in the resistor definition library may be added, deleted, or prioritized in the Manage Resistors menu using the following function keys.

5.7.1.2.1.3.1 READ FILE (F1)

MAIN MENU | CHANNEL SETUP | CHANNEL SETTINGS | SET UP R_s | MANAGE RESISTORS

The Read File function key allows the user to import an entire set of resistor definitions from a file on a USB memory device.

Every resistor definition in the resistor definition library must have a unique ID. If a resistor definition in the library has the same ID as one read from the USB memory device, it will be replaced.



Tip: Resistor definition files must be located in a folder named “\159x\resistor” on the USB memory device. The files must have the extension “.res” and contain resistor definition data in the proper format. This type of file can be created by using the Write File function, see Section 5.7.1.2.1.3.2, WRITE FILE (F2), on page 32 in the Manage Resistors menu.

5.7.1.2.1.3.2 WRITE FILE (F2)

MAIN MENU | CHANNEL SETUP | CHANNEL SETTINGS | SET UP R_s | MANAGE RESISTORS

The Write File function key in the Manage Resistors menu allows the user to export one resistor definition or the entire library to a file on a USB memory device.

If a resistor was selected in the Manage Resistors screen, that resistor definition will be written to a file. If ALL RESISTORS was selected, the entire Resistor Library will be written to a file.

The screen shows the name of the file to be written. The user may change the name of the file by pressing ENTER to open the alpha-numeric editing screen. Finally, the user presses the CONTINUE function key to

write the file. If a USB memory device has not yet been inserted, the user is instructed to do so. Allow about 10 seconds for the system to recognize the USB device before continuing.

Resistor definition files are written to a folder named “\159x\resistor” on the USB memory device and have the extension “.res”. If the file does not exist, it will be created. If the file already exists and one resistor was selected, its resistor definition will be appended to the data in the file. If ALL RESISTORS was selected, the contents of the existing file will be replaced with the resistor definitions in the resistor definition library.

5.7.12.13.3 MOVE UP (F3)

MAIN MENU | CHANNEL SETUP | CHANNEL SETTINGS | SET UP Rs | MANAGE RESISTORS

The Move Up function key changes the arrangement of the reference resistors in the resistor definition library by moving the selected resistor up one position. If the first resistor is selected or if ALL RESISTORS is selected, there is no action.

5.7.12.13.4 MOVE DOWN (F4)

MAIN MENU | CHANNEL SETUP | CHANNEL SETTINGS | SET UP Rs | MANAGE RESISTORS

The Move Down function changes the arrangement of the reference resistors in the resistor definition library by moving the selected resistor down one position. If the last resistor is selected or if ALL RESISTORS is selected, there is no action.

5.7.12.13.5 DELETE RESISTOR (F5)

MAIN MENU | CHANNEL SETUP | CHANNEL SETTINGS | SET UP Rs | MANAGE RESISTORS

The Delete Resistor function key may be used to delete a resistor definition from the resistor definition library.

If a resistor was selected in the Manage Resistors screen, that resistor will be deleted. If ALL RESISTORS was selected, the entire library will be erased.

A message appears prompting the user to confirm the delete operation. The user may press the YES function key to confirm and proceed with deleting the resistor definition or library. Pressing the NO function key cancels the operation and returns to the Manage Resistors menu. Pressing the EXIT key will also cancel the operation with no change.

5.7.2 PROBE MENU (F2)

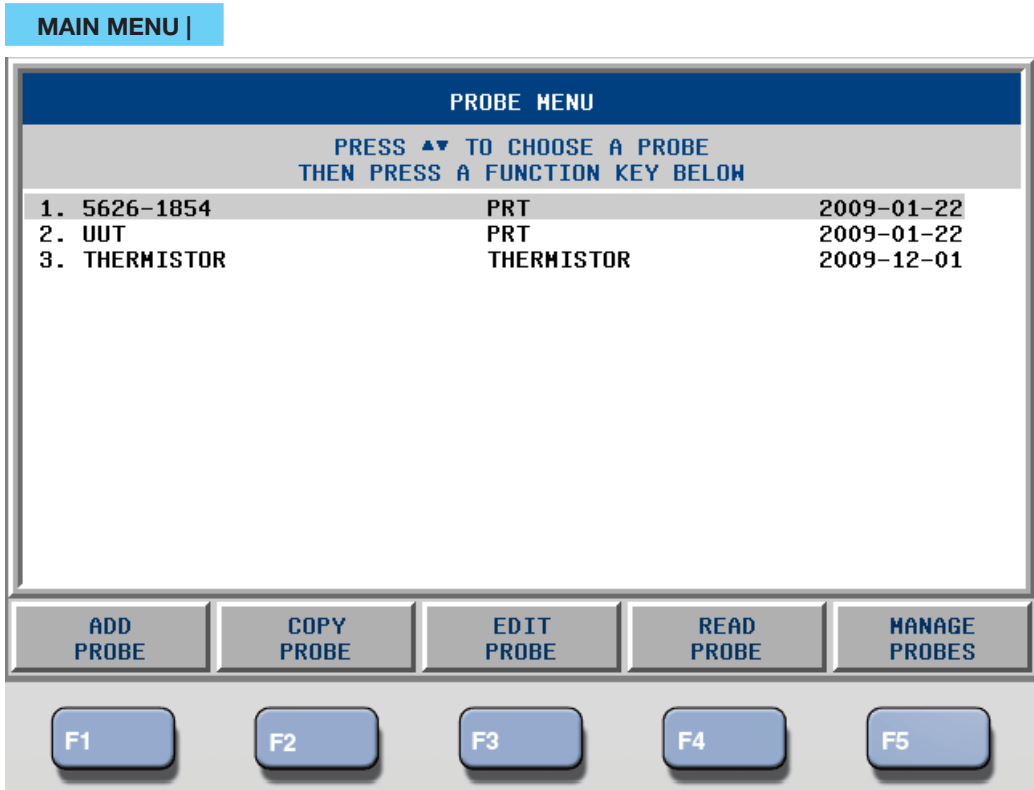

Figure 11 Probe Menu Screen

The Probe Menu contains the function keys needed for editing and managing probe definitions stored in the Probe Library.

The Probe Library is non-volatile memory inside the Super-Thermometer which contains probe configuration information that is configured and stored by the user. A user can easily program probe parameters into the Probe Library and quickly assign the parameters to any of the measurement channels.



Tip: Once the probe definitions are programmed into the Probe Library, they can be conveniently copied to a USB memory device (see Section 5.7.2.5, MANAGE PROBES (F5), on page 37) so they can be backed up and easily reloaded if needed.

The following are descriptions of each function key in the Probe Menu.

5.7.2.1 ADD PROBE (F1)



The Add Probe screen is used to add a new probe definition to the Probe Library. Up to 100 definitions can be stored in the Probe Library. If the limit has been reached, the user will not be allowed to add more probe definitions.

The following fields are used to define a probe configuration:

ID - is the probe ID field. The user may enter alpha or numeric characters to enter a unique probe ID up to 24 characters in length. Duplicate probe IDs cannot be saved. With the ID field selected, pressing ENTER will open the Alpha-Numeric Interface allowing the user to enter the probe ID.

TYPE - defines the type of probe. The options are PRT, THERMISTOR, and RESISTOR. The type selected will determine what other probe configuration fields appear.

CALIBRATION DATE - the calibration date of the probe. The digits may be set to zero if the date is undefined.

NOMINAL CURRENT - the sensing current used for measuring the probe. The value entered is the current used to measure the probe when 1 x Power is selected in the Channel Settings screen. Typical current settings are 1.0 mA for a 25.5 Ω or 100 Ω PRTs and 0.010 mA for 10 kΩ thermistors (see “Table 13 Recommended Reference Resistor for Various Probe Types” on page 30).



Caution: Sensing current must be carefully selected. Current that is too high can overheat and possibly damage a sensor. Refer to the sensor’s manufacturer recommendations when setting the current.

MAXIMUM CURRENT - the maximum allowed sensing current. This setting is used to prevent excessive current from damaging the sensor. This setting supersedes the Nominal Current setting.

MAXIMUM TEMPERATURE - sets the temperature limit for the probe. When a probe’s measured temperature exceeds this setting, a warning message is indicated on the Measurement screen and an audio alarm is sounded if the Alert Beep setting is set to ON (see Section 5.7.4.1, USER SETTINGS (F1), on page 47).

CONVERSION - the type of calibration coefficients or characterization used for the probe. The characterization defines how temperature is calculated for a probe. When conversion is set to NONE, measurements will be in resistance. See the following Probe Conversion Information table for more information.

Table 14 Probe Conversion Information

Type	Conversion	Coefficients	Equations	
PRT	ITS-90	High Subrange 5 (-38 to 29 °C) RTPW,a5, b5 High Subrange 6 (0 to 962 °C) RTPW,a6, b6, c6, d High Subrange 7 (0 to 660 °C) RTPW,a7, b7, c7 High Subrange 8 (0 to 420 °C) RTPW,a8, b8 High Subrange 9 (0 to 232 °C) RTPW,a9, b9 High Subrange 10 (0 to 157 °C) RTPW,a10 High Subrange 11 (0 to 30 °C) RTPW,a11	See ITS-90 literature	
		Low Subrange 1 (13 to 273 K) RTPW,a1, b1,c1,c2,c3 Low Subrange 2 (24 to 273 K) RTPW,a2, b2,c1,c2,c3 Low Subrange 3 (54 to 273 K) RTPW,a3, b3,c1,c2,c3 Low Subrange 4 (-189 to 0 °C) RTPW,a4, b4 Low Subrange 5 (-38 to 0 °C) RTPW,a5,b5		
	PT-100	R0 Use R0 = 100.0 for standard IEC-751, ASTM-E-1137 or enter actual probe R0 for improved accuracy		See IEC-751 or ASTM-E-1137 literature
	CVD-ABC	R0, A, B, C		See CVD literature
	CVD-ALPHA	R0, ALPHA, DELTA, BETA		See CVD literature
POLYNOMIAL	C0, C1,....C7	$t[°C] = \sum_{i=0}^7 C_i R[\Omega]^i$		

Type	Conversion	Coefficients	Equations
THERMISTOR	R(T) POLYNOMIAL	B0, B1, B2, B3	$R[\Omega] = \exp \left(\sum_{i=0}^3 B_i \left[\frac{1}{t[^\circ\text{C}] + 273.15} \right]^i \right)$
	T(R) POLYNOMIAL	A0, A1, A2, A3	$t[^\circ\text{C}] = \frac{1}{\sum_{i=0}^3 A_i [\ln R[\Omega]]^i} - 273.15$
<p>Note: With ITS-90 conversion, where subranges overlap, the high subrange supersedes the low subrange. If only subrange 5 is used in a probe definition, select subrange 5 for both High Subrange and Low Subrange. If a subrange is set to NONE, all temperatures will be based on the programmed subrange (alerts in measurement screen inform the user when a defined ITS-90 subrange is exceeded, see Display Settings submenu in Display Menu).</p>			

The following are the Add Probe Screen function keys.

5.7.2.1.1 TEST CALCULATION (F1)

MAIN MENU | PROBE MENU | ADD PROBE |

The Test Calculation function key helps the user verify the probe calibration coefficients were entered correctly. A resistance is entered and a temperature is calculated based on the calibration coefficients. The calculated temperature is compared with the probe’s calibration report to verify correct coefficient entry.

5.7.2.1.2 SAVE (F2)

MAIN MENU | PROBE MENU | ADD PROBE |

The Save function key saves the newly entered probe information into the Probe Library. Exiting without selecting SAVE cancels all changes.

5.7.2.1.3 CANCEL (F5)

MAIN MENU | PROBE MENU | ADD PROBE

The Cancel function key exits the Add Probe screen without saving changes.

5.7.2.2 COPY PROBE (F2)

MAIN MENU | PROBE MENU |

The Copy Probe function key allows the user to create a new probe definition based on an existing definition.

In the Probe Menu screen, select the probe definition to be copied. Press the COPY PROBE (F2) function key. Update the PROBE ID field with a unique probe ID. Press the SAVE (F2) function key to save the copied definition. If a unique ID is not entered, the ID will be appended with a _1 automatically.

5.7.2.3 EDIT PROBE (F3)

MAIN MENU | PROBE MENU |

The Edit Probe screen is used to edit probe definitions that have been entered into the Probe Library. When Edit Probe is selected, the same probe definition fields found in the Add Probe screen are shown. Refer to Section 5.7.2.1, ADD PROBE (F1), on page 34 for a full description of each field.

Changes made in the Edit Probe screen are not saved until the SAVE (F2) function key is selected. The EXIT key or CANCEL (F5) can be selected at any time to exit without saving changes.

5.7.2.4 READ PROBE (F4)

MAIN MENU | PROBE MENU |

The Read Probe function key allows the user to read a probe definition from the USB memory device into the Probe Library.

When a USB memory device, that contains a probe definition file, is inserted in the front panel, the Read Probe screen displays a list of probe definition files (*.prb) found on the memory device. By scrolling up and down the list using the arrow keys, the user can select the desired probe definition file. Pressing the ENTER key (with the file selected) will open the file and display the probe definitions it contains. At this point a probe definition can be selected and read into the Probe Library by pressing the ENTER key again.

If the selected probe definition in the USB memory device has the same ID as a probe definition that already exists in the Probe Library, a warning message appears warning that the probe definition in the library will be replaced. The user may press the YES function key to update the probe definition and exit, or press NO (or the EXIT key) to return to the Assign Probe screen.



Tip: Probe definition files must be located in a folder named “\159x\probe\” on the USB memory device. The files must have the extension “.prb” and contain probe definition data in the proper format. This type of file can be created by using the Write File function in the Manage Probes menu.

5.7.2.5 MANAGE PROBES (F5)

MAIN MENU | PROBE MENU |

The Manage Probes screen is used for reading probe definition files from memory, writing definition files to memory, moving probe definition locations in the Probe Library and deleting probe definitions.

In the Manage Probe screen, the Probe Library is displayed as well as the following function keys.

5.7.2.5.1 READ FILE (F1)

MAIN MENU | PROBE MENU | MANAGE PROBES |

The Read File function key allows the user to read a probe definition file (.prb) from the USB memory device. A probe definition file may contain multiple probe definition files. The files have to be located in the folder \159x\probe\ in the memory device and have the extension .prb.

A file is read by inserting a memory device containing a valid probe definition file into the front panel. When READ FILE (F1) is pressed, a list of all probe files that reside on the memory device is shown. The file is selected by using the using the arrow keys. The file is transferred to the Probe Library upon pressing the ENTER key and confirming the action.



Important: Any probe definition in the Probe Library that has the same ID as any probe definition in the memory device will be overwritten.

5.7.2.5.2 WRITE FILE (F2)

MAIN MENU | PROBE MENU | MANAGE PROBES |

The Write File function key exports one probe definition file or the entire Probe Library from the Super-Thermometer to the USB memory device.

When in the Manage Probes screen, select either a single probe definition or ALL PROBES (at the end of the list). When WRITE FILE (F2) is selected, the name of the file to which the definitions will be written is displayed. Pressing the ENTER key will open the Alpha-Numeric Interface so the file name can be entered. Pressing CONTINUE (F1) writes the file to memory.

If the \159x\probe\ folder and .prb file have not been created previously, they will be created automatically when the file is written. If the .prb file already exists, a newly written probe definition will be appended into the file. However, if the .prb file already exists and all files are written to memory, the .prb file will be overwritten.

5.7.2.5.3 MOVE UP (F3)

MAIN MENU | PROBE MENU | MANAGE PROBES |

The Move Up function key changes the order of the probe definitions in the Probe Library by moving the selected definition up one position until it reaches the top of the list.

5.7.2.5.4 MOVE DOWN (F4)

MAIN MENU | PROBE MENU | MANAGE PROBES |

The Move Down function key changes the order of the probe definitions in the Probe Library by moving the selected definition down one position until it reaches the bottom of the list (before ALL PROBES).

5.7.2.5.5 DELETE PROBE (F5)

MAIN MENU | PROBE MENU | MANAGE PROBES |

The Delete Probe function key allows the user to delete probe definitions from the Probe Library. If the Probe Library capacity of 100 definitions has been reached, a probe definition has to be deleted before adding another definition.

A single highlighted probe definition can be highlighted and then deleted or all probe definitions can be deleted if ALL PROBES is selected. A message prompts the user to confirm the delete action before it takes place.

5.7.3 MEASURE MENU (F3)

MAIN MENU |

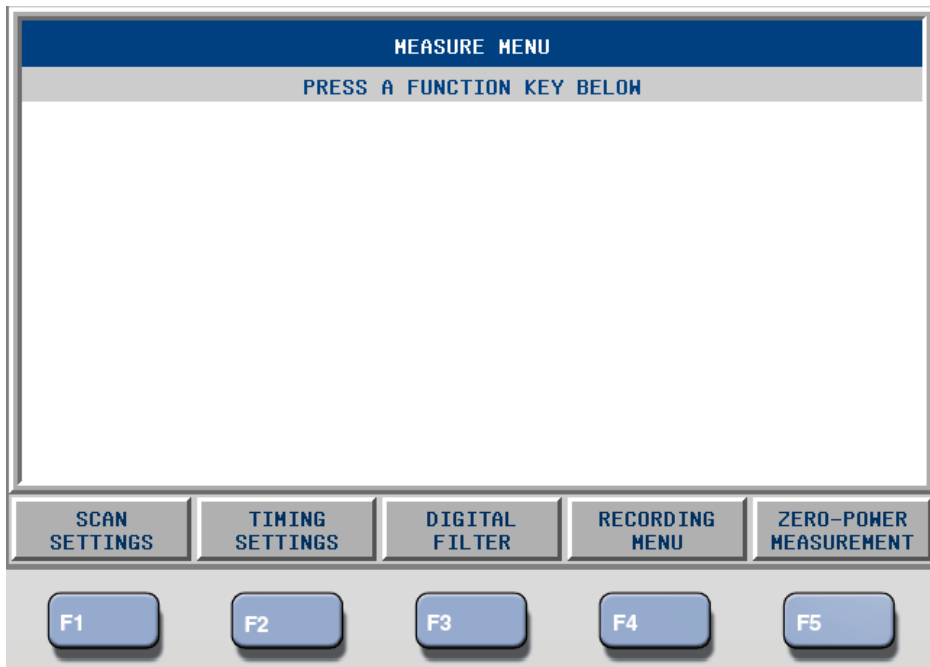

Figure 12 Measure Menu Screen

The Measure Menu contains the function keys needed for setting up channel scanning, measurement timing, digital filter settings, controlling measurement recording, and performing zero-power measurements.

The following are complete descriptions of each function key.

5.7.3.1 SCAN SETTINGS (F1)

MAIN MENU | MEASURE MENU |

Scan Settings is used to set up channel scanning. The Super-Thermometer has several scan options that are configured using the following fields.

SCAN ENABLE- turns scanning on or off by using the Left/Right Arrow Keys and pressing the ENTER key. ON enables automatic sequencing through all enabled channels. OFF disables scanning so only one channel is measured as selected by the user.

REPEAT COUNT- determines how many times a channel is measured before the Super-Thermometer continues to the next channel in the scan sequence. The setting has a range of 1 to 100.

ALTERNATE REFERENCE- automatically measures the reference channel after each individual channel is measured in the scan sequence. This feature is useful in comparison type calibrations when the heat source is not very stable.

REFERENCE CHANNEL- the setting that determines which channel is the reference channel for Alternate Reference. The channel chosen for REFERENCE CHANNEL must be enabled (Section 5.7.1, CHANNEL SETUP (F1), on page 29).

5.7.3.2 TIMING SETTINGS (F2)

MAIN MENU | MEASURE MENU |

The Timing Settings screen contains the settings and function keys needed for the configuration of measurement timing. The timing settings control the measurement process and the length of time it takes to produce and display a measurement.

Measurement Timing Description

The measurement timing settings allow the user to be in control of each phase of the measurement process. These settings enable the user to optimize timing for different applications.

To help describe the measurement process, it is broken into the following five steps.

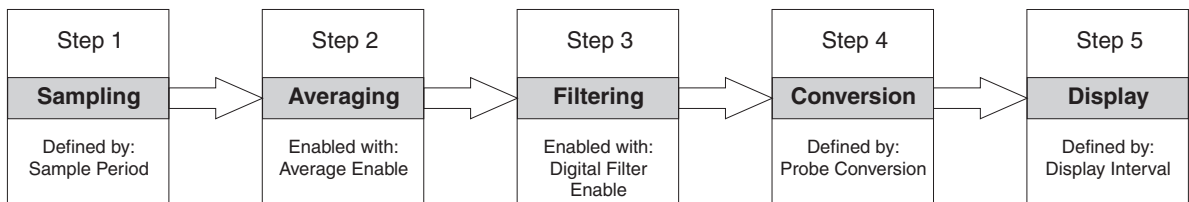

Figure 13 Measurement Process Block Diagram

1. **Sampling** - the fundamental measurement of the Super-Thermometer is the resistance ratio. The fundamental ratio measurement is sampled once per Sample Period.
2. **Averaging** - the fundamental ratio measurements can be averaged (see Average Enable below) or passed directly to Filtering. The number averaged is the number of measurement samples taken during one Display Interval (how often the measurement display is updated). For example, if Sample Period is set to 2 seconds and Display Interval is set to 10 seconds, 5 ratio measurement samples are averaged per Display Interval. The display is updated with the statistical mean of the 5 measurement samples. If AVERAGE ENABLE is OFF, only the most recent ratio measurement sample will be passed to Filtering.
3. **Filtering** - after Averaging, the measurement samples can also be processed with a digital filter (configured by using the Digital Filter function key, Section 5.7.3.3, DIGITAL FILTER (F3), on page

- 41) if the digital filter is ON. If the digital filter is OFF, measurement samples are passed directly to Conversion.
4. **Conversion** - after filtering, the fundamental ratio measurement can be converted to the selected unit of measure such as Temperature (Section 5.7.2.3, EDIT PROBE (F3), on page 36). If RATIO is the selected unit of conversion, the measurement is passed directly to Display.
 5. **Display** - after conversion, the measurement is sent to the display, remote interface, statistics calculations, and memory at a rate of once per Display Interval. The statistical mean that is displayed in the Measurement screen is based on n number of displayed measurements, not number of samples.

The Timing Settings screen contains the following measurement timing fields.

SAMPLE PERIOD - sets the length of time required to obtain a fundamental ratio measurement sample. The options are 1, 2, 5, and 10 seconds. The default option is 2 seconds.



Note: When the sample period is changed, measurement will stop. It must be restarted by the user.

The 1 second option is useful for applications that require measurements at the highest possible speed, such as thermal response tests. However, it can be expected to observe greater measurement noise will be greater when using a 1 second sample period. The 2 seconds option provides good stable measurements for most types of thermometer probes. The 10 seconds option may yield better results for very high resistances or with probes that have unusually large settling effects which may be caused by electrical leakage or dielectric absorption. A probe may be tested for electrical settling by comparing measurements made with the 2 seconds and 10 seconds sample periods.

With the 1 second and 2 seconds options the sensing current is reversed at a basic interval of 0.2 second. With the 5 seconds and 10 seconds options the current is reversed at a basic interval of 1.2 seconds.

Sample Period cannot be larger than the Display Interval setting.

DISPLAY INTERVAL - determines how often measurements are passed to the display, statistics fields, memory, and remote interface ports. Possible options are 1, 2, 10, 30, and 60 seconds. The default option is 2 seconds. Changing the Display Interval setting may affect the Sample Period setting, as Sample Period cannot be greater than Display Interval.

AVERAGE ENABLE - determines whether fundamental measurement samples are averaged before being passed to the digital filter step. If Average Enable is ON, all fundamental measurements acquired during the Display Interval are combined by averaging. If Average Enable is OFF, or if Sample Period is the same as Display Interval, only a single sample, the most recent, is passed to the next step in the measurement process. The default option is ON.

STOP TIMER ENABLE - enables or disables the stop timer, which stops measurement after a specified length of time. If Stop Timer Enable is ON, the stop timer begins counting down when measurement is started using the START MEASUREMENT (F1) function key in the Measurement screen, and stops measurement automatically when the timer elapses. If STOP TIMER ENABLE is OFF (default setting is OFF), measurement continues indefinitely until the user stops measurement.

When the stop timer is enabled and measurement is enabled, an hourglass symbol and the time remaining, in hours, minutes, and seconds appears at the bottom of the Measurement screen.

TIMER DURATION - sets the stop timer duration. The value is a number of hours, minutes, and seconds, ranging from 00:00:01 to 23:59:59. The default value is 01:00:00. This setting is only relevant when Stop Timer Enable is ON.

AUDIO INDICATION - enables or disables the audio alert that tells the user when the stop timer elapses and measurement stops. The default option is ON.

The Sample Period, Display Interval and Average Enable settings in the Timing Settings menu can be automatically configured by selecting one of the following preset function keys (a full description of each field can be found later in this section):

PRESET NORMAL (F1) - is used for most applications. This setting provides a balance between speed and precision. Sample Period and Display Interval are both set to 2 seconds and Average Enable is set to ON.

PRESET PRECISION (F2) - sets the timing settings for minimal measurement noise and settling error with most thermometer probes. Sample Period is set to 2 seconds, Display Interval is set to 10 seconds, and Average Enable is set to ON.

PRESET FAST (F3) - is used to configure the Super-Thermometer for the fastest possible measurements. Sample Period and Display Interval are both set to 1 second. Measurement noise and electrical settling errors may be greater in Fast mode. Fast mode is useful for certain applications such as probe response time testing.

PRESET LONG (F4) - sets the timings settings for better results with probes that exhibit long electrical settling times. Measurement noise might be slightly higher. Sample period is set to 10 seconds, Display Interval is set to 10 seconds and Average is set to ON.

5.7.3.3 DIGITAL FILTER (F3)

MAIN MENU | MEASURE MENU |

The Digital Filter screen is used to change the digital filter settings and clear the digital filter buffer.

Digital Filter Description

The digital filter is a moving average filter that computes the arithmetic mean of display measurements stored in a buffer. The size of the buffer is user-defined via the Average Count setting. If the buffer is full, the oldest measurement in the buffer is discarded when a new measurement enters the buffer. If the buffer is only partly filled, the mean is still computed using the limited number of stored measurements.

If the digital filter is enabled, the most recent measurement coming from Averaging (see Measurement Sequence Diagram in the previous section) is averaged with the previous display measurements stored in the digital filter buffer. For example, if Display Interval is set to 10 seconds, and the digital filter average count is 20, a new display measurement is averaged with the previous 19 display measurements for a window size of 200 seconds ($n = 20$).

The buffer is cleared when measurement is started or if a measurement is out-of-range. This may occur, for example, if a probe is disconnected from a channel. It may also be cleared by the user at any time using the CLEAR FILTER (F1) function. This clears the filter for all channels at once.

The Digital Filter configuration settings and function key are as follows:

FILTER ENABLE - enables or disables the digital filter. The default option is ON.

AVERAGE COUNT - sets the number of Display Interval measurements that are averaged by the digital filter. The setting has a range of 2 through 100. The default value is 30. This setting is only meaningful when Filter Enable is ON.

5.7.3.3.1 CLEAR FILTER (F1) - clears the filter buffer.



Tip: It is useful to use Clear Filter to clear the digital filter buffer when an abrupt change to the data has occurred. This allows the filtered measurements to settle more quickly.

5.7.3.4 RECORDING MENU (F4)

MAIN MENU | MEASURE MENU |

In the Recording Menu, the user can control how measurements are recorded to a memory device (external or internal). This menu is also used for manipulating data files including exporting of data and erasing data.

Measurements may be stored in either of two possible memory devices; Internal Memory or a external USB Memory Device. Internal memory can store up to approximately 80,000 individual measurements. A USB flash memory device can typically store an even greater quantity of data, depending on the memory size. Both types of memory devices are non-volatile, meaning the data is preserved even when the power is switched off. However, some data may be lost if the power is switched off as data is being written.



Important: Avoid switching power off to the Super-Thermometer while measurement and recording are in progress or recorded data may be lost.

Measurements are recorded when the START RECORD (F5) function key in the Measurement screen has been pressed. The Status Bar at the bottom of the Measurement screen indicates if recording is ON or OFF.

Each recorded measurement includes the date and time of the measurement, channel, measured value, and unit. Additional statistical data is also recorded when the Record Statistics setting is ON.

The data written into internal memory is organized into data sets and each data set is identified by the date and time of the first measurement in the set. A new data set is started each time the START RECORDING (F5) function key is selected if measurement is on. Likewise, a new data set is started each time the START MEASUREMENT (F1) function key is selected if recording is on.

Data is recorded to the USB file in ASCII text, comma separated values (CSV) format, one measurement per line. Each line is terminated with a carriage return and linefeed. The format of a line of data when the Record Statistics setting is OFF is as follows:

<measurement value>,<unit>,<channel number>,<date and time>

Example: 231.927562,C,4,2010-01-10 14:23:10

When RECORD STATISTICS is ON, the format is as follows:

<measurement value>,<unit>,<channel number>,<date and time>,<ratio>,<resistance>,<mean>,<std dev>

Example: 231.927562,C,4,2010-01-10 14:23:10,1.89280433,47.318163,231.927848,0.000231

USB files are written to a folder named “\159x\data” on the USB memory device and have the extension “.txt”. If the file does not exist, it will be created. If the file already exists, new data will be appended to the data already in the file. For data to be recorded to external memory, a Linux compatible USB memory device formatted with a FAT32 file system must be inserted into the USB Connection on the front panel.

The following are the Recording Menu function keys.

5.7.3.4.1 RECORDING SETTINGS (F1)

MAIN MENU | MEASURE MENU | RECORDING MENU |

The Recording Settings function key opens a screen that allows the user to view and change settings related to measurement recording. The configuration fields in the Recording Settings screen are as follows:

MEMORY DEVICE - allows the user to choose which memory device to be written to. The options are Internal, USB or Both.

USB FILE - is a user-selectable file name to which data is stored on the USB memory device. Upon pressing Enter, the Alpha-Numeric Interface opens allowing the user to input a file name. The file name extension “.txt” is automatically appended to the file name.

RECORD STATISTICS - determines whether statistics data is recorded to the memory device along with the measurement. Additional data recorded when Record Statistics is ON include Resistance Ratio, Resistance, Statistical Mean, and Standard Deviation. When Record Statistics is ON, the capacity of the memory device, in terms of number of measurements, is reduced by about a factor of two.

The function key used to Start and Stop Recording is located in the Measurement Menu, Section 5.6.10, START/STOP RECORD (F5), on page 28.

5.7.3.4.2 VIEW DATA (F2)

MAIN MENU | MEASURE MENU | RECORDING MENU |

The View Data function key is used to view measurements that have been recorded into internal memory. The View Data screen displays the list of datasets recorded in memory. The user pages through the datasets using the Left/Right Arrow Keys and views data in a dataset using the Up/Down Arrow Keys.

5.73.4.3 READ FILE (F3)

MAIN MENU | MEASURE MENU | RECORDING MENU |

The Read File function key allows the user to view measurements that have been recorded in a file on the USB memory device. If a USB device has not been inserted in the front panel, the user will be prompted to do so.

A list of files appears on the screen and the user selects the file to be opened using the arrow keys and then opens the file by pressing the ENTER key. When the file is opened, the contents are displayed and the arrow keys are used to move through the file to view the data.

5.73.4.4 WRITE FILE (F4)

MAIN MENU | MEASURE MENU | RECORDING MENU |

The Write File function key is used to copy data from internal memory onto the USB memory device.

The user may select a dataset using the Left and Right arrow keys. ALL DATA (in the DATA SET field) can be used to transfer all datasets to the USB device. The USB device filename can be entered by moving the cursor to the USB FILE field and pressing the ENTER key to display the Alpha-Numeric Interface.

If the data set and filename have been selected, the user presses CONTINUE (F1) to start the transfer. If the file already exists, the user will be prompted to continue and append the data to the existing file.

5.7.3.4.5 ERASE DATA (F5)

MAIN MENU | MEASURE MENU | RECORDING MENU |

The Erase Data function key is used to erase a selected data set or all data sets, using ALL DATA at the end of the list, from internal memory. The user may select a data set using the Up/Down arrow keys and pressing the ENTER key. Upon pressing CONTINUE (F1), a warning message will appear and the user must confirm the action to continue. Pressing the EXIT key or CANCEL (F2) function key at any point during this process exits the menu without deleting data.



Important: Do not turn power off while data is being erased because the internal memory files may be lost.

5.7.3.5 ZERO-POWER MEASUREMENT (F5)

MAIN MENU | MEASURE MENU |

The Zero-Power function key is used for configuring and performing zero-power measurements.

Zero-Power Measurement Description

When measurement current is passed through a temperature probe sensor, the sensor self-heats and creates a measurement error. Probe self-heating errors vary by probe construction, current levels, and ability of the measurement medium to dissipate heat from the probe. Measurements in air are especially prone to self-heating. The Zero-Power Measurement function can be used to remove measurement error caused by self-heating. It can also be used to measure the error due to self-heating.

The Zero-Power Measurement function automatically acquires the measurements necessary to determine a probe's zero-power resistance, temperature or ratio. This is done by measuring the probe at two levels of current (nominal current and 1.4142 times nominal) and then using these measurements to calculate the value at zero-power.

While the Super-Thermometer is performing a zero-power measurement, the timing is set to produce a measurement every two seconds and the digital filter is disabled. The statistical average is calculated from all measurements acquired during the Measure Time.



Tip: Zero-Power measurements must be performed in a very stable heat source so temperature drift does not interfere with the calculation.

Zero-power measurement is performed by first measuring the probe at nominal current. Then the excitation current is automatically changed to 1.4142 times the nominal current. 1.4142x of the nominal current is referred to as double power excitation current since the power dissipated is twice that of nominal current. The zero-power value is then calculated with the following equation:

where Z is the zero-power value, N is the nominal current value, and D is the double-power value.



Important: The probe definition must be configured so that the Maximum Current setting is at least 1.4142x the nominal current setting.

An alternative method of zero-power measurement, enabled by the Repeat Nominal setting, adds an additional nominal current measurement taken after the 1.414x reading. The zero-power value derived from this technique is calculated with the following:

where Z is the zero-power value, N_1 is the first nominal current value, D is the double-power value, and N_2 is the final nominal current value.

The difference between the first and final nominal current readings indicates whether the probe's temperature has changed during zero-power measurement. This is important since a change in temperature could introduce error into the zero-power calculation. When Repeat Nominal is enabled, the Super-Thermometer reports the difference between the two nominal current values as Drift.

When a zero-power measurement is completed, the results are displayed on the screen and written to memory. The values displayed are Channel Number, Probe ID, Zero-Power Measurement, Sensing Current, Mean, and Standard Deviation for each step and the Nominal Current Self-Heating Offset.

The configuration fields and function keys in the Zero-Power Measurement screen are as follows:

CHANNEL - specifies the channel on which the measurement will be done. Only one channel at a time can be measured in zero-power mode.

SETTLE TIME - sets the time allowed for measurement settling after a change in current. The value (00:00) is in minutes and seconds. The settle time needed varies by probe construction and measurement medium. The default value is 01:00 (1 minute). Measurements taken during Settle Time are discarded.



Tip: Settle time is important since it takes some time for a probe's temperature to stabilize when the current level changes. Therefore, it is important to choose a settle time appropriate for the probe and the measurement environment.

MEASURE TIME - sets the time period over which measurements are averaged for each portion of the zero-power sequence. For example, if a Measure Time of 1 minute is selected, measurements will be taken at each current level over a 1 minute span and the resulting average will be used in the zero-power calculation. The number of samples included in the average is based on the Measure Time and the Display Interval setting.

The Measure Time setting is in minutes and seconds. The setting has a range of 00:10 to 10:00. The default value is 01:00.

REPEAT NOMINAL - enables or disables the Repeat Nominal option mentioned above. When enabled, the nominal current measurement will be repeated after the 1.4142x measurement.

AUDIO INDICATION - enables or disables the Audio Alert feature that alerts the user when the zero-power measurement sequence is completed.

START (F1) - starts the zero-power measurement sequence

When the START (F1) function key is selected, the zero-power measurement sequence begins and the screen displays the following fields and function key:

CHANNEL - the measurement channel

PROBE - the ID of the probe

TIME REMAINING - the amount of time left to complete the zero-power sequence of measurements in minutes and seconds (00:00)

STEP - indicates the current measurement step of the sequence

SENSING CURRENT - the sensing current implemented in the measurement step

PHASE - indicates whether measurement is in **SETTLING** or **MEASURING** mode

MEAN - the arithmetic mean of the measurements taken in the current step

STD DEV - the standard deviation of the measurements used to calculate the mean

CANCEL (F1) - terminates the zero-power measurement sequence

Once the Zero-Power Measurement sequence is complete, the following results are reported on the screen.

DATE - the date of the measurement

TIME - the time when the measurement finished

CHANNEL - the channel measured

PROBE - the ID of the probe configuration

ZERO-POWER RESULT - the calculated zero-power value

SELF-HEATING - the amount the probe measurement changes due to self-heating

STANDARD ERROR - the resulting standard error of the mean of the zero-power result

DRIFT - indicates the difference between the nominal current measurements (applies only if Repeat Nominal is enabled)

SENSING CURRENT 1 - the measurement current used in the first step of the sequence

MEAN 1 - the mean of the measurements in the first step

STD DEV 1 - the standard deviation of the measurements in the first step

SENSING CURRENT 2 - the measurement current used in the second step of the sequence

MEAN 2 - the mean of the measurements in the second step

STD DEV 2 - the standard deviation of the measurements in the second step

(the following apply if Repeat Nominal is enabled)

SENSING CURRENT 3 - the measurement current used in the third step of the sequence

MEAN 3 - the mean of the measurements in the third step

STD DEV 3 - the standard deviation of the measurements in the third step

The measurement results can be written to memory by pressing the **WRITE FILE (F1)** function key. The user may change the file name by pressing the **ENTER** key and using the alpha-numeric interface. Once the file name is set, and after the USB memory device is inserted into the front USB port, the user presses the **CONTINUE (F1)** function key to proceed to write the file. The file is stored in a folder named “\159x\zero”. If the file already exists, the new test results are added to the file.

The results of the zero-power measurement are written to the file as follows:

DATE,<date>

TIME,<time>

CHAN,<channel number>

PROBE, <probe ID>
ZERO_MEAS, <corrected measurement>, <unit>
SELF_HEAT, <self heating>, <unit>
STAN_ERR, <standard error>, <unit>
DRIFT, <drift>, <unit>
CURR_1, <current 1>, mA
MEAN_1, <mean 1>, <unit>
SDEV_1, <standard deviation 1>, <unit>
CURR_2, <current 2>, mA
MEAN_2, <mean 2>, <unit>
SDEV_2, <standard deviation 2>, <unit>
CURR_3, <current 3>, mA
MEAN_3, <mean 3>, <unit>
SDEV_3, <standard deviation 3>, <unit>



Note: DRIFT is recorded only if Repeat Nominal is enabled.

VIEW PREVIOUS (F2) - displays the most recent set of zero-power measurement data results

5.7.4 DISPLAY MENU (F4)

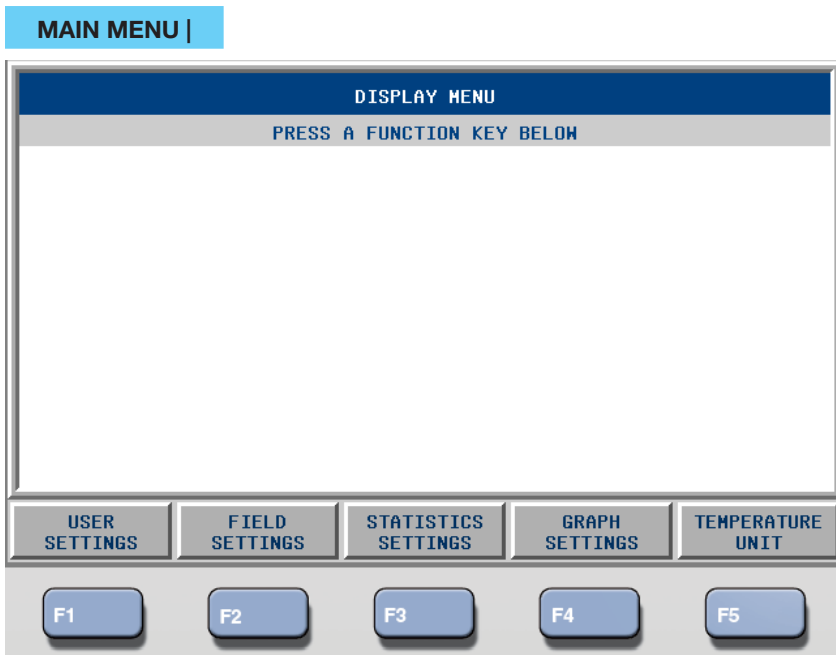

Figure 14 Display Menu Screen

The Display Menu is used for configuring the display settings, selecting statistics settings and choosing the displayed temperature measurement units.

5.7.4.1 USER SETTINGS (F1)

MAIN MENU | DISPLAY MENU |

The User Settings screen allows the user to set preferences such as language, temperature measurement resolution, screen saver settings and alert messages.

The User Settings screen will automatically appear as the initial screen if the Start-up Help setting is enabled (see below). This assists a first-time user in setting preferences and setting the clock to the local time. The User Settings screen can also be conveniently reached directly from the Measurement Screen at any time by pressing and releasing the ENTER key and then pressing the SETUP key. When reached this way, it will appear in English regardless of the language setting.

The following configuration fields are displayed in the User Settings screen.

LANGUAGE - sets the language in which the menus and screens are displayed. The options are ENGLISH, CHINESE, JAPANESE, SPANISH, GERMAN, FRENCH, and RUSSIAN. ENGLISH is the default option.

DATE FORMAT - sets the format used to display dates on the screen. Available options are YYYY-MM-DD, MM-DD-YYYY, and DD/MM/YYYY. The default format is YYYY-MM-DD. This setting has no effect on communications commands and responses, recorded data, or library files.

DECIMAL FORMAT - sets the decimal character used in decimal numbers on the display. Available options are period (.) and comma (,). The default option is (.). This setting has no effect on communications commands and responses, recorded data, or library files.

TEMPERATURE RESOLUTION - sets the desired number of decimal places that appear in displayed temperature measurements. Available options are 0.1 through 0.000001. The default option is 0.00001. The actual number of decimal places of displayed temperatures may be reduced for large numbers. This setting has no effect on communications commands and responses, recorded data, or library files. The resolution of displayed resistances and resistance ratios is fixed at the maximum practical resolution.

SCREEN SAVER ENABLE - enables or disables the screen saver. When the screen saver is enabled (ON), the display backlight is switched off after the screen saver wait time specified by the Screen Saver Wait setting if no keys are pressed. Pressing any key resets the screen saver wait time and, if the display was blanked, switches the display on. If Screen Saver Enable is OFF, the display will remain on indefinitely. Enabling the screen saver saves power and extends the lifetime of the display. The default option is OFF.

SCREEN SAVER DELAY - sets the screen saver delay time. Available options are 5 min, 10 min, 15 min, 30 min, 45 min, 1 hr, and 2 hr. The default option is 1 hr. This setting is only relevant when Screen Saver Enable is ON.

DISPLAY BRIGHTNESS - sets the brightness of the display backlight. Available options are 50 %, 60 %, 70 %, 80 %, 90 %, and 100 %. The default option is 100 %. Reducing the display brightness saves power and extends the lifetime of the display. In brightly lit environments, the screen may be easier to read when Display Brightness is set to a higher value.

ITS-90 SUBRANGE ALERT - enables (ON) or disables (OFF) the alert message that appears at the bottom of the Measurement screen when a temperature measurement from a probe using the ITS-90 Conversion is more than 10°C outside the range covered by the selected subranges. The default option is ON.

Rs DUE ALERT - enables (ON) or disables (OFF) the alert message that appears at the bottom of the Main Screen when the due date of a resistor in the Resistor Library is past. The default option is OFF.

ALERT BEEP - enables (ON) or disables (OFF) the audio indication that accompanies alert messages. The default option is ON.

KEYPAD BEEP - enables (ON) or disables (OFF) the audio indication that accompanies each key-press. The default option is ON.

START-UP HELP - determines whether the User Settings screen appears automatically after power-on. When set to ON, the User Settings screen will appear as the first screen. If the setting is OFF the Measurement Screen will appear instead. The default option is ON.

When the User Settings screen appears after power-on, when the Start-Up Help setting is ON, the User Settings screen includes function key NEXT (F1). This key leads to the Time and Date Settings screen (see Section 5.7.5.1, TIME DATE (F1), on page 50), where the clock may be set to the local time.

5.7.4.2 FIELD SETTINGS (F2)

MAIN MENU | DISPLAY MENU |

The Field Settings function key is used for selecting statistical fields to display in the Measurement Screen. A particular set of statistical fields can be stored as a set and recalled using the RECALL MEMORY selection. Four different sets can be stored in Recall Memory, any of which can be restored to factory defaults using the RESTORE DEFAULT (F1) function key (see Default Statistical Fields table below). Restore Default only affects the Recall Memory selection that is currently display.

Individual statistical fields in any of the Recall Memory sets can be changed by first selecting the RECALL MEMORY set number, pressing the ENTER key, arrowing down to the field to be changed, changing the field with the Left/Right arrow keys and pressing the ENTER key save the change. The available data field options and their descriptions are listed in the tables below.

Table 15 Default Statistical Fields

Field	Memory 1	Memory 2	Memory 3	Memory 4
1	MEAN	MEAN	MAXIMUM	MEAN
2	STD DEV	STD DEV	MINIMUM	STD DEV
3	SE OF MEAN	N	DELTA	TIME
4	RESISTANCE	RESISTANCE	RESISTANCE	DATE

Table 16 Statistical Field Descriptions

Option	Description	Equation
MEAN	arithmetic mean of measurements	$Mean = \frac{1}{n} \sum_{i=1}^n y_i$
STD DEV	sample standard deviation of measurements	$Std Dev = \sqrt{\frac{1}{n-1} \left(\sum_{i=1}^n y_i^2 - n \cdot Mean^2 \right)}$
SE OF MEAN	standard error (estimated standard deviation) of the mean	$SE of Mean = \frac{(std dev)}{\sqrt{n}}$
MAXIMUM	maximum measurement	
MINIMUM	minimum measurement	
SPREAD	difference between maximum and minimum	$Spread = Maximum - Minimum$
N	number of measurements (sample size)	
DELTA	difference relative to a delta channel or offset	
RESISTANCE	resistance measurement	
RATIO	resistance ratio measurement	
TIME	time from the system clock	
DATE	date from the system clock	

As a note of further explanation, SE OF MEAN provides an estimate of the uncertainty ($k = 1$) of the MEAN value. SE OF MEAN is calculated from the sample standard deviation of *unfiltered* measurements (not the same as the displayed standard deviation of filtered measurements) and the sample size. The method used to calculate SE OF MEAN disregards the effect of the digital filter since it causes correlation among displayed measurements. Otherwise the result of the formula for SE OF MEAN would produce an erroneously low value.

5.7.4.3 STATISTICS SETTINGS (F3)

MAIN MENU | DISPLAY MENU |

The Statistics Settings screen allows the user to set statistics related settings such as the statistics mode to be used.

STATISTICS MODE – determines the mode in which statistics are used. The options are LIMITED and UNLIMITED.

In Limited mode, statistics are calculated using a sliding window that is limited in width by the number of samples defined in the Sample Count setting. The oldest measurement leaves the sliding window buffer when a new measurement enters.

Unlimited mode allows the number of samples to grow indefinitely until the user resets the statistics or stops measurement.

SAMPLE COUNT - defines the number of samples on which the statistics are based. In LIMITED mode, this setting defines the width of the sliding window. A maximum of 100 can be selected.

DELTA MODE - determines whether the Delta statistics field is based on a measurement from a channel or an offset entered by the user. The options are CHANNEL or OFFSET.

DELTA OFFSET - sets the offset value used for calculating Delta. This setting applies when Delta Mode is set to OFFSET.

When the Delta Offset value is subtracted from a measurement, it assumes the same units as the measurement. The setting has a range of -1.0E06 to 1.0E06.



Tip: Delta Mode is useful for automatically subtracting an offset from a measurement such as the lead resistance offset used when making 3-wire measurements.

DELTA CHANNEL- specifies the channel to be used as the reference for the Delta calculation. This setting is applicable when Delta Mode is set to CHANNEL. Possible options are channels 1 through 4 when no scanner is attached. If a scanner is attached, channel 1 is not available but the scanner channels are.

5.7.4.4 GRAPH SETTINGS (F4)

MAIN MENU | DISPLAY MENU |

The Graph Settings function key opens a screen that contains settings for controlling how data graphs appear in the Measurement Screen in Show Graph mode. The configuration fields in the Graph Settings screen are as follows:

COMBINED GRAPH - determines if all enabled channels are plotted on the same graph or on separate graphs. ON plots all channels on the same graph.

TIME SPAN - configures the horizontal time scale or width of the graph window. The options are 5 min, 10 min, 15 min, 30 min, 1 hr, 2 hr, 4 hr, and 8 hr. The default is 10 min.

AUTOMATIC CENTERING - determines whether the center of the vertical axis is set automatically based on the data in the graph (ON) or if the center is fixed at the Vertical Center value (OFF). The default value is ON.

VERTICAL CENTER - sets the center of the vertical axis of the combined graph when Automatic Centering is ON. The setting has a range of -1.0E6 to 1.0E6. The default value is 0.0.

AUTOMATIC SCALING - determines whether the scale of the vertical axis is set automatically based on the data in the graph (ON) or if the scale is fixed at the Vertical Scale value (OFF). The default value is ON.

VERTICAL SPAN - sets the scale of the vertical axis of the combined graph when Automatic Scaling is OFF. The setting has a range of 1.0E-6 to 1.0E6. The default value is 0.1.

TRACE - controls whether a measurement point is plotted with a line that connects to the previous point or as a separate dot. The options are LINE and DOT. The default value is DOT.



Important: When Time Span is large, multiple points may be combined and drawn as a vertical line to conserve memory.

5.7.4.5 TEMPERATURE UNIT (F5)

MAIN MENU | DISPLAY MENU |

The Temperature Unit screen allows the user to select the unit for displayed temperature measurements. The options are °C, K, and °F. °F will not be available if SI Unit Lock is set to ON in the Calibration Parameters screen of the Calibration menu (see Section 5.7.7.2, CALIBRATION (F5), on page 55). The default value is °C.

5.7.5 SYSTEM MENU (F5)

MAIN MENU |

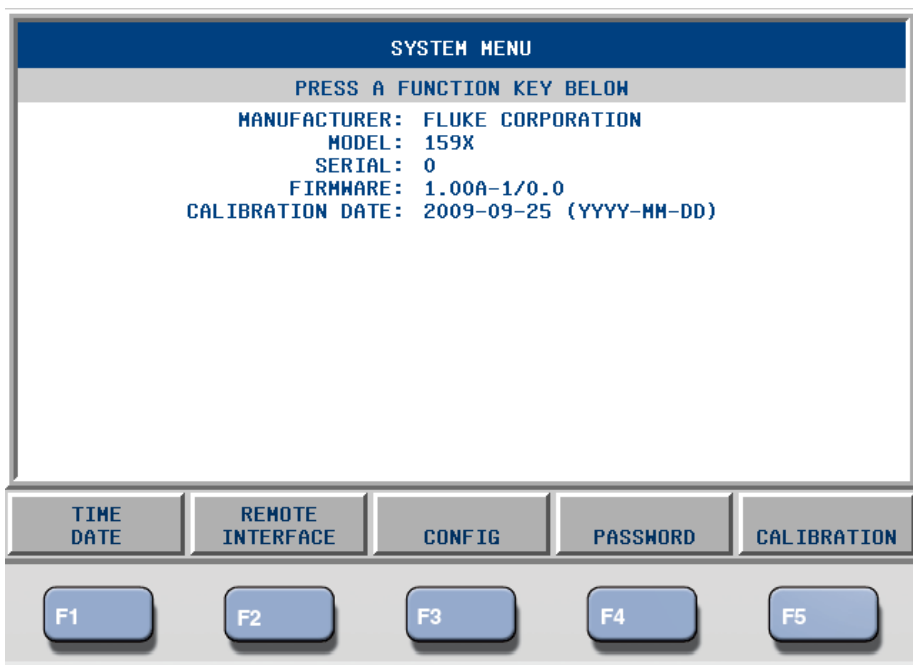

Figure 15 System Menu Screen

The System Menu contains general system settings such as time and date, remote interface, password, and calibration.

The System Menu screen displays the following product information: Manufacturer, Model, Serial Number, Firmware Version, and Calibration Date.

The following are the System Menu function keys:

5.7.5.1 TIME DATE (F1)

MAIN MENU | SYSTEM MENU |

The Time and Date function key allows the user to enter the system Time and Date using the following fields:

TIME - time of the system clock. It is always in 24-hour format.

DATE - date of the system clock. It appears in the format determined by the Date Format setting (see Section 5.7.4.1, USER SETTINGS (F1), on page 47).

DAYLIGHT SAVING - determines whether the clock is automatically adjusted at the beginning and end of the Daylight Saving period. Options are OFF, NORTH AMERICA, and EUROPE. The default option is OFF.

5.7.5.2 REMOTE INTERFACE (F2)

MAIN MENU | SYSTEM MENU |

The Remote Interface screen contains the function keys used for configuring and monitoring the remote interface ports. For more information on the Remote Interface ports and a list of remote operation commands, see Section 8, Remote Operation, on page 65.

The following are the function keys located in the Remote Interface menu.

5.7.5.2.1 SERIAL (F1)

MAIN MENU | SYSTEM MENU | REMOTE INTERFACE |

The Serial function key is used to configure the RS-232 serial port with the following configuration fields:

BAUD RATE - baud rate setting of the serial port. It may be set to 1200, 2400, 4800, 9600, 19200, or 38400. The default setting is 9600.

LINEFEED - determines whether a linefeed character (ASCII code 10) is transmitted at the end of every message.

5.7.5.2.2 USB (F2)

MAIN MENU | SYSTEM MENU | REMOTE INTERFACE |

The USB function key displays the following configuration field:

PORT ENABLE – enables and disables the rear USB port for remote communications with a computer (The front USB port, used for an external USB memory device, is always enabled).

5.7.5.2.3 NETWORK (F3)

MAIN MENU | SYSTEM MENU | REMOTE INTERFACE |

The Network function key opens a screen allowing the user to configure the Network port settings.

The network port implements a 10/100 Base T Ethernet network interface. It supports the protocols TCP/IP, DHCP, and HTML. The port is disabled by default and must be enabled to be used. The user may select DHCP or specify a static network address.

The network port may be used for remote control of the Super-Thermometer by a PC and interface to network software such as Telnet or a COM port redirector driver. In this mode, the network port accepts a raw TCP connection on TCP port number 5025.

The network port also provides a simple HTML web page interface to the Super-Thermometer to allow remote monitoring via a web browser.

The following are the configuration fields:

HARDWARE MAC - shows the hardware MAC address of the network port. It cannot be changed.

DHCP ENABLE - determines whether the static IP address is used or is assigned dynamically by a server. The default option is ON (dynamic).



CAUTION: When DHCP is enabled, do not remove the Ethernet cable and turn the power off. The cable needs to remain plugged into the unit while cycling the power.

IP ADDRESS - specifies the network port's IP address when DHCP is OFF, or shows the dynamically assigned IP address when DHCP is set to ON.

GATEWAY - specifies the gateway server's IP address to be used when DHCP is OFF.,

SUBNET MASK - specifies the network's subnet mask when DHCP is OFF. Gateway and Subnet Mask are not available when DHCP is set to ON.

HOST NAME - is a name that may be used to identify the Super-Thermometer on the network. It may consist of a combination of letters and digits, up to 16 characters in length. The first character must be a letter. Hyphen characters are allowed within the Host Name string. The default Host Name is "F159X-<serial number>", where <serial number> is the unique serial number of the Super-Thermometer.

CONTROL ENABLE - determines whether remote interface commands are accepted via the network port. The options for this setting are OFF, ON, and QUERY ONLY. When the setting is OFF, the Super-Thermometer will not accept or respond to any commands received from the network port. When the option is ON all commands are allowed, though some may be password protected. The QUERY ONLY option allows data and settings to be read but not changed. The default is ON.



Important: When Control Enable is either OFF or QUERY ONLY, the web page will not be fully functional.

5.7.5.2.4 IEEE-488 (F4)

MAIN MENU | SYSTEM MENU | REMOTE INTERFACE |

The IEEE-488 function key opens the IEEE-488 configuration screen with the following configuration fields:

PORT ENABLE - determines whether the IEEE-488 port is enabled (ON). When the port is disabled, no communications can occur. The default option is OFF.

ADDRESS - is the IEEE-488 address assigned to the Super-Thermometer. It must be different than all other equipment on the IEEE-488 bus. The address may be set to any number between 1 and 30 inclusive. The default setting is 22.

TERMINATION - determines whether a carriage return character (ASCII code 13) or linefeed character (ASCII code 10) terminates a response. The default option is LINEFEED. An IEEE-488 EOI message also accompanies the final character of every transmission.

The IEEE-488 port accepts either, or any combination of, a linefeed, carriage return, or EOI as a terminator.

The CLEAR INTERFACE (F1) function key is used to clear the input and output buffers and reset the IEEE-488 interface, just as if the IFC or SDC control message was received.

5.7.5.2.5 ERRORS (F5)

MAIN MENU | SYSTEM MENU | REMOTE INTERFACE |

The Errors screen allows the user to view errors stored in the remote interface error queue. They can also be read using the remot command "SYST:ERR?" (see Section 8, Remote Operation, on page 65)

The screen shows a list of all the errors, with the earliest error at the top. Errors are identified with their queue position number, error code, and message string. The error queue can hold up to ten errors. If the queue overflows with errors, the last error is replaced with a "Queue overflow" error message.

The Errors screen contains the CLEAR ERRORS (F1) function key that, when pressed, clears all errors from the error queue.

5.7.5.3 CONFIG (F3)

MAIN MENU | SYSTEM MENU |

The Configuration screen provides the means for storing the instrument configuration and recalling it later. Several different configurations may be stored to allow quick and easy setup from user to user or from one application to another. The following function keys are located in this screen.

5.7.5.3.1 STORE CONFIG (F1)

MAIN MENU | SYSTEM MENU | CONFIG |

The Store Configuration function allows the user to store settings to a configuration file in either internal non-volatile memory or a USB flash memory device. The following settings are stored:

- The probe definition assigned to each channel
- Enable state of each channel
- Channel settings, including the reference resistor selections
- Resistor definition assigned to each reference resistor input
- Scan settings
- Timing settings
- Digital filter settings
- User Settings
- Statistics fields settings
- Statistics settings
- Graph settings
- Temperature unit
- Recording settings

The Store Configuration function does not store probe definitions, resistor definitions, time and date, remote interface port settings, password settings, calibration parameters, or recorded data.

MEMORY DEVICE - specifies to which memory device the configuration is stored. The options are USB and INTERNAL. The default option is INTERNAL. Up to 50 configuration files may be stored internally. The number of files stored on a USB device is limited only by the storage space available.

FILE NAME - specifies the name of the configuration file. It is edited or entered by first pressing the ENTER key, which opens the Alpha-Numeric Interface. The file name may have up to 24 characters. The user must press the SAVE (F3) function key when finished. If the file does not exist, it is created. If it already exists, the contents of the file are replaced. The file name extension “.txt” is automatically added to the file name when the file is created. Once the memory device and file name are selected, the user presses the STORE (F1) function key to proceed.

USB configuration files are written to a folder named “\159x\config” on the USB memory device and have the extension “.txt”. When writing the file to a USB memory device, a formatted USB memory device must be inserted into the USB socket on the front panel.

5.7.6 RECALL CONFIG (F2)

MAIN MENU | SYSTEM MENU | CONFIG |

The Recall Configuration screen displays the configuration files that have been saved to memory. The location of the file(s) must be selected using the MEMORY DEVICE field. The options are INTERNAL and USB.

Once the memory location is selected, pressing ENTER or the CONTINUE (F1) function key will open the list of configuration files. Using the Up/Down arrow keys, the configuration is selected. Pressing ENTER or the CONTINUE (F1) function key opens the file. The user is prompted to continue before the changes are implemented.

The Recall Configuration function does not affect probe definitions, resistor definitions, time and date, remote interface port settings, password settings, calibration parameters, or recorded data. If an assigned probe definition no longer exists in the Probe Library when a configuration is recalled, the channel is set to UNDEFINED. Likewise, a reference resistor input will be set to VARIABLE if the resistor ID is not found in the Resistor Library.

5.7.7 DELETE CONFIG (F3)

MAIN MENU | SYSTEM MENU | CONFIG |

The Delete Configuration function may be used to delete a configuration file in internal memory. The screen shows a list of configuration files found in the internal non-volatile memory. The user presses the Up/Down arrow keys to select one of the configuration files, then CONTINUE (F1) or ENTER to delete the file. The user must confirm the action before the configuration is deleted.

5.7.7.3.1 RESTORE DEFAULT (F4)

MAIN MENU | SYSTEM MENU | CONFIG |

The Restore Default function may be used to restore settings to factory default values. The user must press the YES (F4) function key to run the restore function. The NO (F5) function key or EXIT key will exit the screen without restoring default settings. The settings that are affected are listed in the Store Configuration section.

5.7.7.3.2 UPDATE FIRMWARE (F5)

MAIN MENU | SYSTEM MENU | CONFIG |

The Update Firmware function key may be used to update the internal software to a newer version when available from the manufacturer.

The Update Firmware function is always password protected. The user will be prompted to enter the correct password to proceed.

A message appears instructing the user to plug in a USB memory device that contains the firmware update file.

A confirmation message screen appears prompting the user to press YES to proceed. While the firmware update file is being read from the USB and loaded into the system, the power must not be switched off. If the power is switched off during the firmware update process, the instrument may no longer operate and will need to be returned to the factory for servicing.



Caution: Do not switch off the power while the firmware is being updated.

Once the firmware update process is completed, a message indicates that the firmware has been successfully updated. The user must then switch the power off and then on to restart and operate with the new firmware.

5.7.7.1 PASSWORD (F4)

MAIN MENU | SYSTEM MENU |

In the Password screen the user may view and change password settings. The Password screen is always password protected (the default is 1234). The user will be prompted to enter the correct password to access the screen. Password protection can be enabled for probe configurations, resistor definitions, certain measure functions, and system time/date settings. See the following configuration field descriptions for more detail.

PASSWORD - a four-digit number that must be entered by the user in order to change settings in any password protected screen. The user may change the password to any four-digit number. The default is 1234.



Important: The user must be sure to remember the password or record the password in a safe location. If the password is forgotten or lost, the instrument must be returned to the factory to have the password reset.

PROBE PROTECTION - enables or disables protection of probe definition related screens. This setting is useful for ensuring that probe definitions in the Probe Library do not get inadvertently changed. The default is OFF.

RESISTOR PROTECTION - enables or disables protection of resistor definition related screens. This setting is useful for ensuring that resistor definitions in the Resistor Library do not get inadvertently changed. The default is OFF.

MEASURE PROTECTION- enables or disables protection of measurement setting screens. This setting is used for ensuring that timing and digital filter settings do not get inadvertently changed, possibly resulting in noisy or less accurate measurements. The default is OFF.

TIME/DATE PROTECTION- enables or disables protection of the Time and Date setting screen. The default is OFF.

Some screens are always protected and have no associated protection setting. An example is the Calibration Parameters screen, which always requires the correct password before any of the settings can be changed.

5.7.7.2 CALIBRATION (F5)

MAIN MENU | SYSTEM MENU |

The Calibration menu contains functions and settings for testing and maintaining proper performance of the Super-Thermometer. Refer to Section 9, Calibration, on page 103 for test and calibration instructions.

The following are the Calibration Menu function keys.

5.7.7.2.1 SYSTEM TEST (F1)

MAIN MENU | SYSTEM MENU | CALIBRATION |

The System Test function key is used to perform a system self-test. This tests various components of the Super-Thermometer and reports the results. If System Test indicates failures, contact the nearest Fluke Authorized Service Center. See Section 9.2, SYSTEM TEST (F1), on page 103 for more information.

5.7.7.2.2 CURRENT TEST (F2)

MAIN MENU | SYSTEM MENU | CALIBRATION |

The Current Test function allows the user to test the accuracy of the sensing current on the front panel input channels.

See Section 9.3, CURRENT TEST (F2), on page 103 for more information on how to perform a current test.

5.7.7.2.3 RATIO CALIBRATION (F3)

MAIN MENU | SYSTEM MENU | CALIBRATION |

The Ratio Self-Calibration function allows the user to perform a ratio linearity check or calibration. A check allows the user to verify ratio accuracy without making changes to ratio parameters. Calibration measures the Super-Thermometer ratios and makes adjustments to the ratio parameters. A check should always be performed after running the ratio self-calibration function to verify that alignment was successful. See Section 9.4, RATIO CALIBRATION (F3), on page 104 for more information.

5.7.7.2.4 RESISTANCE CALIBRATION (F4)

MAIN MENU | SYSTEM MENU | CALIBRATION |

The Resistance Calibration function allows the user to test and calibrate the internal reference resistors. See Section 9.5, RESISTANCE CALIBRATION (F4), on page 106 for more information.

5.7.7.2.5 CALIBRATION PARAMETERS (F5)

MAIN MENU | SYSTEM MENU | CALIBRATION |



Important: Calibration parameters should not be changed except as part of the Super-Thermometer calibration procedure performed by a qualified service technician.

In the Calibration Parameters screen the user may view and change measurement calibration settings. The calibration parameters can be viewed with no password but a password is required to make changes.

Calibration parameters include calibrated values for each of the internal resistors and the linearity coefficients for the resistance ratio measurements. Since the accuracy of the Super-Thermometer depends on these values, they must be accurate. Refer to Section 9.4.2, ADJUST PARAMETERS (F2), on page 106 for instructions needed to adjust the calibration parameters.

Apart from the calibration parameters, the Calibration Parameters screen also includes the following configuration fields:

CALIBRATION DATE- used to record the date the Super-Thermometer is calibrated.

SI UNIT LOCK- enables or disables °F as an allowed temperature unit option. When this is set to ON, temperatures may be displayed in units of °C and K only, and °F will not be available as an option for the Unit setting (see Section 5.7.4.5, TEMPERATURE UNIT (F5), on page 50).

6 Getting Started

6.1 Powering on the Super-Thermometer



CAUTION: Before powering the Super-Thermometer on, ensure that the line voltage selection is set properly. Refer to Section 3.3, Line Voltage and Fuses, on page 15 for instructions.

Power the Super-Thermometer on by setting the power switch located on the back panel to the On position. After power is on, pressing the Power Standby switch on the front panel puts the system into hibernation, leaving key components such as the resistor oven powered on.

The first time the unit is powered on, the User Settings screen will be displayed after startup. Later in the section it will be explained how this feature is turned off so the Measurement screen is displayed when the unit is powered on.

6.2 User Settings Screen

The User Settings screen allows the user to configure system settings such as language, temperature measurement resolution, screen saver settings and alarms. As mentioned previously, the User Settings screen is the first displayed upon the first power-up if the Start-Up Help setting is enabled. This setting can be turned off by the user after the user settings have been configured.

The following fields are displayed in the User Settings screen:

LANGUAGE- sets the language in which the menus and screens are displayed. The options are ENGLISH, CHINESE, JAPANESE, SPANISH, GERMAN, FRENCH, and RUSSIAN. ENGLISH is the default option.

DATE FORMAT- sets the format used to display dates on the screen. Available options are YYYY-MM-DD, MM-DD-YYYY, and DD/MM/YYYY. The default option is YYYY-MM-DD. This setting has no effect on communications commands and responses, recorded data, or library files.

DECIMAL FORMAT- sets the decimal character used in decimal numbers on the display. Available options are period (.) and comma (,). The default option is (.). This setting has no effect on communications commands and responses, recorded data, or library files.

TEMPERATURE RESOLUTION- sets the desired number of decimal places that appear in displayed temperature measurements. Available options are 0.1 through 0.000001. The default option is 0.00001. The actual number of decimal places of displayed temperatures may be reduced for large numbers. This setting has no effect on communications commands and responses, recorded data, or library files. The resolution of displayed resistances and resistance ratios is fixed at the maximum practical resolution.

SCREEN SAVER ENABLE- enables or disables the screen saver. If Screen Saver Enable is OFF, the display will remain on indefinitely. Enabling the screen saver saves power and extends the lifetime of the display. The default option is OFF.

SCREEN SAVER DELAY- sets the screen saver delay time. Available options are 5 min, 10 min, 15 min, 30 min, 45 min, 1 hr, and 2 hr. The default option is 1 hr.

DISPLAY BRIGHTNESS- sets the brightness of the display backlight. Available options are 50 %, 60 %, 70 %, 80 %, 90 %, and 100 %. The default option is 100 %. Reducing the display brightness saves power and extends the lifetime of the display.

ITS-90 SUBRANGE ALERT- enables (ON) or disables (OFF) the warning message that appears at the bottom of the Measurement Screen when a probe's measured temperature exceeds its ITS-90 subrange by more than 10°C. The default option is ON.

Rs DUE ALERT- enables (ON) or disables (OFF) the warning message that appears at the bottom of the Measurement screen when the due date of a resistor in the Resistor Library has expired. The default option is OFF.

ALERT BEEP- enables (ON) or disables (OFF) the audio indication that accompanies warning messages. The default option is ON.

KEYPAD BEEP- enables (ON) or disables (OFF) the audio indication that accompanies each key-press. The default option is ON.

START-UP HELP- determines whether the User Settings screen appears automatically after power-on. When the settings is ON the User Settings screen will appear every time the power is switched on. If the setting is OFF the Measurement screen will appear instead. The default option is ON.



NOTE: The following apply after power-on when Start-Up Help is on:

Pressing the NEXT (F1) function key continues to the Time and Date screen allowing the user to enter the system Time, Date and Daylight Saving settings with the following configuration fields:

TIME- is the time of the system clock. It is always in 24-hour format.

DATE- is the date of the system clock. It appears in the format determined by the Date Format setting (see Section 6.2, User Settings Screen, on page 57).

DAYLIGHT SAVING- determines whether the system clock is automatically adjusted at the beginning and end of the Daylight Saving period. Options are OFF, NORTH AMERICA, and EUROPE.

The user settings sequence is completed by selecting the NEXT (F1) function key at which point the user is prompted to allow the user settings screen to be displayed upon power-up. After making the selection, the Channel Setup screen is shown to help the user set up a measurement.

6.3 Connecting a Probe or Resistor



CAUTION: Incorrect sensing current can damage a probe or resistor. Before connecting a device to the Super-Thermometer ensure that the sensing current setting does not exceed the limit of the device.

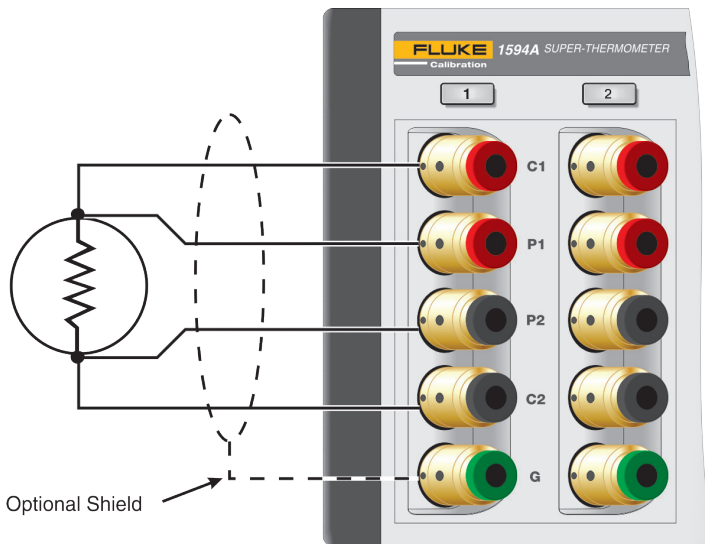

Figure 16 Input Wiring

The Super-Thermometer measurement inputs are equipped with patented gold-plated DWF connectors. These connectors are spring-loaded to provide constant contact pressure with measurement connections and they require little maintenance.

The DWF connectors are designed to accept spade connectors (by pressing the connector open), bare wire (inserted in one of the side holes while pressing the connector open), and banana jacks (inserted in the front). For best results, always use wires and connectors that are clean and free of corrosion and oxidation.

The DWF connectors are labeled with C1, C2 (current connections) and P1, P2 (measurement potential connections). The guard connector is labeled with a “G” and is used for connecting to a probe or resistor guard or shield. The guard connection may help reduce measurement noise.

Connect a probe or resistor, as specified by the device’s manufacturer, to any one of the four measurement channels located on the front panel. To prevent the possibility of applying too much current, suspend measurement sampling and configure the channel before making the connection.

7 Making Measurements

7.1 Introduction

The Super-Thermometer has been designed to allow quick and easy measurement setup while providing flexible measurement options. The purpose of this section is to guide the user through the configuration of the Super-Thermometer for typical measurements.

7.2 Measuring a Temperature Probe

The following instructions apply to the setup of both PRTs and thermistors for temperature measurement.

1. Press and hold the EXIT key to go to the Measurement screen.
2. If necessary, suspend measurement by pressing the STOP MEASUREMENT (F1) function key.
3. Using the instructions in the Getting Started section, connect a temperature probe to one of the measurement input channels.
4. Press the SETUP key to open the Channel Setup screen. Use the Up/Down arrow keys to highlight the channel to which the probe is connected. Scanner channels, if available, are identified with a S1 (scanner 1) or S2 (scanner 2) prefix added to the channel number.
5. Once the channel is highlighted, use the following steps to assign a probe definition to the selected channel.
 - a. Select the ASSIGN PROBE (F1) function key to open the Probe Library.
 - b. Scroll through the list of probe definitions using the Up/Down arrow keys to locate the probe's definition. If the probe definition has not been previously entered, select ADD PROBE (F1) to begin the process of creating a probe definition (see Section 5.7.2, PROBE MENU (F2), on page 34 for more information).
 - c. When the probe definition is selected, press the ENTER key to assign the selected probe definition to the channel and return to the Channel Setup menu.
6. Select the CHANNEL SETTINGS (F2) function key to configure the measurement channel using the following steps:
 - a. Select the desired reference resistor (Rs) to be used for the measurement by pressing the Left/Right arrow keys and pressing ENTER to confirm the selection. Use "Table 17 Recommended Reference Resistors and Sensing Current" on page 62 as a guide for the selection.
 - b. Enter the correct sensing current using Table 17 on page 62 or the probe manufacturer's instructions as a guide.
 - c. Determine whether standby current (see Channel Setup section) is to be On or Off.
 - d. Select the desired measurement calculation. The options are RESISTANCE (to output the probe's resistance only), RATIO (to output the ratio of the probe's resistance versus the reference resistor), and TEMPERATURE (only if calibration coefficients were entered in the probe definition).
 - e. Press the EXIT key to move back to the Channel Setup screen.

7. If the desired measurement channel is set to Off, use the ON/OFF (F3) function key to toggle the channel to On. Pressing the Channel Select key located above the channel connection will also set the channel to On.
8. Press the EXIT key twice (or press and hold the EXIT key) to go to the Measurement screen.
9. In the Measurement screen, select the START MEASURE (F1) function key to start measurement sampling.

Table 17 Recommended Reference Resistors and Sensing Current

Probe Type	Reference Resistance	Sensing Current
25 Ω SPRT	25 Ω	1.0 mA
100 Ω PRT or RTD	100 Ω	1.0 mA
2.5 Ω SPRT	10 Ω	5.0 mA
0.25 Ω SPRT	1 Ω	14.14 mA
1000 Ω PRT or RTD	10 kΩ	0.05 mA
Thermistors, 2 kΩ to 10 kΩ	10 kΩ	0.01 mA

7.3 Scanning Multiple Temperature Probes

Use the following instructions to configure the Super-Thermometer for scanning multiple temperature probes.

1. Follow the steps in the previous section “Measuring a Temperature Probe” to connect and configure two or more temperature probes.
2. Press the MENU key to open the Main Menu screen.
3. Select the MEASURE MENU (F3) function key to open the Measure menu.
4. Select the SCAN SETTINGS (F1) function key.
5. Set SCAN ENABLE to On. If needed, configure the other scan settings.
6. Press the SETUP key.
7. In the Channel Setup screen, ensure that each channel to which a probe is connected is enabled (set to ON). Disable all other channels by setting them to Off. An alternative method is to press the channel select key above each channel to enable or disable the channel in the scan sequence.
8. Press and hold the EXIT key to return to the Measurement screen.
9. Begin scanning by selecting the START MEASUREMENT (F1) function key.

7.4 Measuring Resistance Ratio

The ratio measurement is the fundamental measurement from which the resistance and temperature measurements are derived. It is simply the ratio (R_x/R_s) between an unknown resistance (R_x) and a reference resistor (R_s).

To configure the Super-Thermometer for ratio measurement, follow the steps listed in section 5.2 except select RATIO in step 6.d.

7.5 Configuring an External Reference Resistor

The Super-Thermometer is equipped with a set of internal resistors. If needed, up to four external resistors can be connected using R_{s1} and R_{s2} inputs on the back panel and Ch2 and Ch4 inputs on the front panel. Use the following instructions for connecting and measuring with an external resistor:

1. Suspend measurement by going to the Measurement screen and pressing the STOP MEASUREMENT (F1) function key.
2. Connect a reference resistor using one of the R_s inputs. Ensure the current and potential connections are correct.
3. Go to the Add Resistor screen by using the following steps:
 - a. Press the SETUP key to open the Channel Setup screen.
 - b. Select the CHANNEL SETTINGS (F2) function key.

- c. Select the SETUP RS (F1) function key.
- d. Select the DEFINE RESISTOR (F2) function key.
- e. Select the ADD RESISTOR (F1) function key.
4. Enter a unique ID in the ID field. Pressing the ENTER key will open the Alpha-Numeric Interface for text entry.
5. Enter the resistance value of the resistor in the RESISTANCE VALUE field.



Caution: *The Resistance Value field is used in measurement for the calculation of the Rx resistance. Entering this value incorrectly will cause measurement error.*

6. Set the maximum measurement current allowed for the reference resistor.
7. If necessary, enter the calibration date and due date for the external reference resistor. The Super-Thermometer will use the due date to warn the user when the resistor is due for calibration.
8. Select the SAVE (F1) function key to save the definition.
9. Press the EXIT key to go up one menu to the Set Up Rs screen. Use the Up/Down arrow keys to highlight the Rs input to which the external resistor is connected.
10. Select the ASSIGN RESISTOR (F1) function key to open a list of defined reference resistors. Use the Up/Down arrow keys to highlight the resistor's definition. Press the ENTER key to assign the resistor to the selected Rs input.
11. Now, when selecting the reference resistor in Section 7.2, Measuring a Temperature Probe, on page 61, step 6.a, the newly entered external resistor will appear as an option.

7.6 Making A Zero-Power Measurement

A temperature probe self-heats when measurement current is passed through its sensing element. Typically self-heating will cause measurement error. The Super-Thermometer Zero-Power function allows the user to measure how much a probe self-heats. It is also able to automatically measure a probe at zero-power. Use the following instructions for performing a zero-power measurement:

1. Press and hold the EXIT key to go to the Measurement screen.
2. If necessary, suspend measurement by pressing the STOP MEASUREMENT (F1) function key.
3. Using the instructions in the Getting Started section, connect a temperature probe to one of the measurement input channels.
4. Configure the probe definition ensuring that the MAXIMUM CURRENT field is set to a value equal to or greater than 1.4142 times the nominal current value.
5. Open the ZERO-POWER MEASUREMENT screen by pressing the MENU key, then the MEASURE MENU (F3) function key, followed by the ZERO-POWER MEASUREMENT (F5) function key.
6. In the Zero-Power Measurement screen, set CHANNEL to the channel where the probe is connected.
7. Set the SETTLE TIME field to a sufficient time period to allow the probe to self-heat and stabilize after current is applied. For most probes 1 minute is sufficient.
8. Set the MEASURE TIME field to a time span that allows a sufficient number of samples to be taken. For example, with a 2-second sample period and 2-second Display Interval, a 1-minute Measurement Time will yield 30 samples.
9. If necessary, use REPEAT NOMINAL to set the Super-Thermometer to repeat nominal current measurement after the 1.4142X step is complete. The difference between the beginning and ending nominal current values will indicate if the probe was sufficiently equilibrated during zero-power measurement.
10. When ready, press the START (F1) function key to start the zero-power sequence of measurements.
11. When the measurements are complete, the results are displayed on the screen.





8 Remote Operation

8.1 Introduction

This section contains instructions for controlling the Super-Thermometer remotely through the available remote operation ports. See Table 18 for a list of the available remote operation ports.

The remote operation commands listed at the end of this section are applicable with all of the remote operation ports.

Table 18 Remote Operation Ports

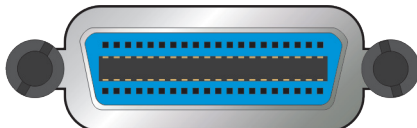
Connection	Description
<p style="text-align: center;">LAN</p> 	Ethernet connector that allows connection to a network for controlling the instrument and transmitting measurements
<p style="text-align: center;"> COMPUTER</p> 	USB port that allows the instrument to be controlled as a USB peripheral from a computer
<p style="text-align: center;">RS-232</p> 	9-pin subminiature D type serial port that can be used to control the instrument via RS-232
<p style="text-align: center;">IEEE-488</p> 	IEEE-488 Input/Output that is compatible with IEEE-488 interface and the IEC 625 Bus for controlling the instrument

8.2 Configuring the Network (LAN) Port

The LAN (Local Area Network) port allows the Super-Thermometer to be controlled remotely through a traditional Ethernet IP network. With this port, the user may control the Super-Thermometer remotely using the commands listed at the end of this section. In addition, once the port is configured properly, the Super-Thermometer can be accessed with the Super-Thermometer Interface web application on a PC.

The LAN port implements a 10/100 Base T Ethernet network interface. It supports the protocols TCP/IP, DHCP, and HTML. The port is disabled by default and must be enabled to be used. The user may select DHCP or specify a fixed network address.

The network port may be used for remote control of the Super-Thermometer by a PC and interface to network software such as Telnet or a COM port redirector driver. In this mode, the network port accepts a raw TCP connection on TCP port number 5025.



CAUTION: When DHCP is enabled, do not remove the Ethernet cable and turn the power off. The cable needs to remain plugged into the unit while cycling the power.

Configuring the LAN port is accomplished through the Remote Interface section of the System menu. The LAN configuration parameters are HARDWARE MAC, DHCP ENABLE, IP ADDRESS, GATEWAY, SUBNET MASK, HOST NAME, and CONTROL ENABLE.

To configure the LAN port settings:

1. Press the MENU key.
2. Select the SYSTEM MENU (F5) function key
3. Select the REMOTE INTERFACE (F2) function key
4. Select the NETWORK (F3) function key
5. Use the following instructions to configure each setting.



Note: When addressing some LAN addresses, computers will often interpret 0's in the IP address as OCTAL values. As an example, if an IP address is entered into the Super-Thermometer as 129.196.017.023 and then an attempt to establish communication to the instrument, the IP address of 129.196.17.23 should be used. Attempting to establish a connection to 120.196.017.023 may result in a connection request to 129.196.15.19.



Important: When changing LAN settings, leave the Super-Thermometer connected to the network and cycle the power to activate any changes made.

8.2.1 Hardware Mac Address

HARDWARE MAC is the address of the network port. It is set at the factory and cannot be changed.

8.2.2 Selecting Dynamic Host Configuration Protocol (DHCP)

Dynamic Host Configuration Protocol (DHCP) is a client-server protocol that eliminates having to manually set permanent/static IP addresses. The DHCP server provides configuration parameters (dynamic IP address, subnet mask, and default gateway IP addresses) which are required for a client to participate in an IP network,

Using DHCP is the easiest way to configure the Super-Thermometer for remote operation in a network. DHCP is enabled by default from the factory. When connected to a network, and the LAN port is enabled, the Super-Thermometer will try and retrieve the parameters from a DHCP server that are necessary for communication. If the parameters can't be obtained, communication will not work.



Important: Before enabling or disabling DHCP, ensure the Super-Thermometer is connected to the network by plugging the network cable into the LAN port on the Super-Thermometer. Always cycle the power after making changes to DHCP.

To disable or enable DHCP, in the NETWORK screen, arrow down to DHCP ENABLE and use the Left/Right arrow keys to select ON (enable) or OFF (disable).

8.2.3 Setting a Static Internet Protocol (IP) Address

An internet (IP) address is required for all internet and TCP/IP communications. If DHCP is enabled, the Super-Thermometer will use the dynamic address supplied by the DHCP server. However, if DHCP is disabled, the configured static IP address will be used.

The Super-Thermometer comes from the factory with IP address set to 0.0.0.0.



Note: If the Super-Thermometer will be used on a corporate network and DHCP is not used, contact the network administrator for a static IP address to be used exclusively by the Super-Thermometer. DHCP must be disabled to use a static IP address.

To enter a static IP address, use the following steps:

1. In the NETWORK screen, use the Up/Down arrow keys to select DHCP ENABLE.
2. IF DHCP is set to ON, use the Left/Right arrow keys to select OFF. Press the ENTER key to save the change.
3. Arrow down to IP ADDRESS and enter the desired static IP address using the front panel keys. Press the ENTER key to save the IP address.
4. Cycle the unit's power to allow the new address to take effect.

8.2.4 Setting the LAN Gateway Address

If communication to the Super-Thermometer passes through a router or gateway, and DHCP is disabled, the subnet mask and gateway address on both the host computer and the Super-Thermometer must be set. Get the correct subnet mask and gateway address from the network administrator.

The gateway address is the IP address of a gateway (router) attached to the same network as the Super-Thermometer. When the instrument detects that a host computer is not on the same network (using the network number), the data is sent through the gateway to reach the host computer.

The gateway address is a 32-bit number. This number is represented as four, 3-digit numbers. The default subnet mask address set from the factory is 0.0.0.0.

To change gateway address, use the following steps:



Note: Gateway address is not available if DHCP is enabled. Disable DHCP before entering the gateway address.

1. In the NETWORK screen, use the Up/Down arrow keys to select GATEWAY.
2. Use the front panel numeric keys to enter the gateway address. Press the ENTER key to save the address.
3. Cycle the unit's power to allow the new address to take effect.

8.2.5 Setting the LAN Subnet Mask

If communication to the Super-Thermometer passes through a router or gateway, and DHCP is disabled, the subnet mask and default gateway address on both the host computer and the Super-Thermometer must be set. Get the correct subnet mask and gateway address from the network administrator.

The subnet mask is a 32-bit number. This number is represented as four, 3-digit numbers. The default subnet mask address set from the factory is 255.255.255.0.

To change subnet mask address, use the following steps:



Note: Subnet mask address is not available if DHCP is enabled. Disable DHCP before entering the subnet mask address.

1. In the NETWORK screen, use the Up/Down arrow keys to select SUBNET MASK.
2. Use the front panel numeric keys to enter the subnet mask address. Press the ENTER key to save the address.
3. Cycle the unit's power to allow the new address to take effect.

8.2.6 Setting the Host Name

The Host Name is the host portion of the domain name, which is translated into an IP address. The default host name is "F159X-<serial number>", where <serial number> is the unique serial number of the Super-Thermometer.

To change the Host Name, use the following steps:

1. In the NETWORK screen, use the Up/Down arrow keys to select HOST NAME.
2. While HOST NAME is highlighted, pressing the ENTER key opens the Alpha-Numeric Interface allowing the user to enter a host name up to 16 characters in length.
3. Select the SAVE (F3) function key to save the newly entered host name.
4. Cycle the unit’s power to allow the new host name to take effect.

8.3 Using the Web Interface

The Super-Thermometer web interface (“Figure 17 Super-Thermometer Web Interface” on page 68) allows the user to easily communicate with the Super-Thermometer through the Ethernet connection. The web interface is a page that is served by the Super-Thermometer when the LAN port is configured and connected to a network. The user is able to access the web interface by simply entering the IP address of the Super-Thermometer in an internet browser.



Important: The LAN port must be properly configured and connected to a network before the web interface tool will operate. The computer used to view the web interface must be on the same network.

The Home screen of the web interface displays product information and the current TCP/IP settings of the Super-Thermometer. The Measure screen of the web interface provides a remote view of the Super-Thermometer display with buttons and selection boxes that allow the user to start and stop measurement, reset statistics, clear alert messages, enable and disable scan mode, and select measurement channels.

The Terminal screen of the web interface allows the user to enter any remote operation command in the Command window. If a command requires a reply from the Super-Thermometer, the reply will appear in the Response window. A password is required to use the Terminal screen. The default password is 1234. A new password can be configured in the System Menu, Password screen.

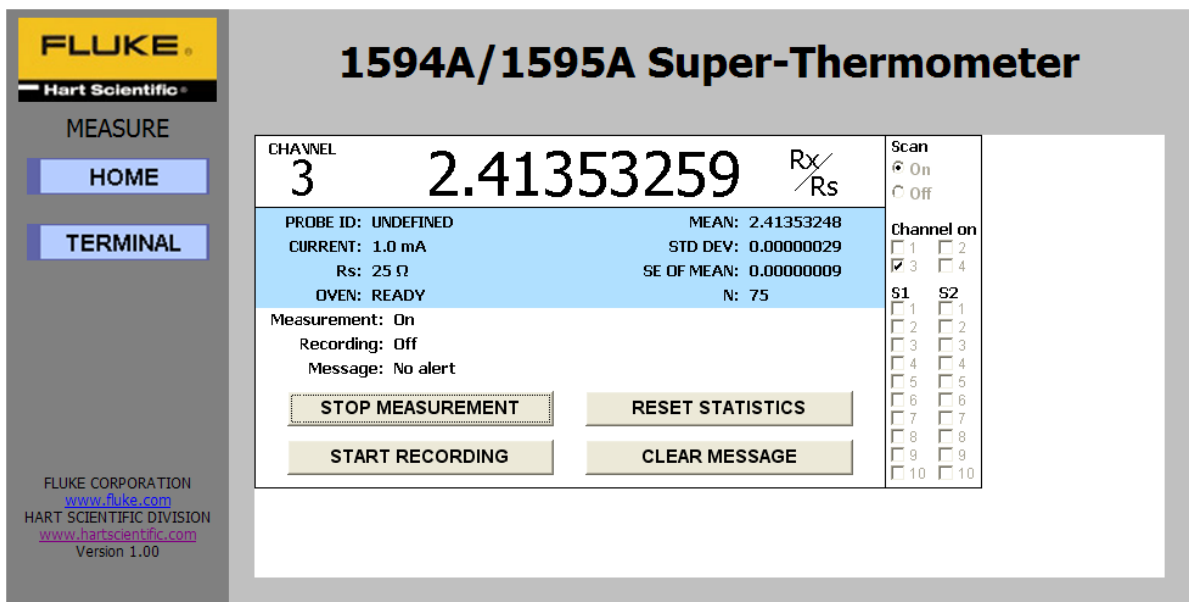

Figure 17 Super-Thermometer Web Interface

8.4 Configuring the USB Port

The rear USB device port (Type B), labeled COMPUTER, allows the Super-Thermometer to be controlled by a computer as a USB peripheral.

The USB port must be enabled before communication. Use the following steps to enable the rear USB port:

1. Press the MENU key.
2. Select the SYSTEM MENU (F5) function key
3. Select the REMOTE INTERFACE (F2) function key
4. Select the USB (F2) function key
5. Use the Left/Right arrow keys to change PORT ENABLE to ON (enable).

Before plugging the USB communication cable from the Super-Thermometer into a computer, make sure the computer is connected to the internet to allow the USB driver to download and install in the computer automatically.

If an internet connection is not available, the computer will detect the Super-Thermometer as an unknown USB device and will prompt for a driver. Insert the DVD provided with the Super-Thermometer into the computer and browse into the USB driver folder. When the driver is selected, the PC will automatically load it. The user may be prompted a second time to browse to the USB driver folder and repeat the process.

When the Super-Thermometer is recognized by the computer, it is ready for communication. Search in the computer's operating system to find the com port address assigned to the USB port connected to the Super-Thermometer. Once the com port address is identified, remote operation commands can be sent using the com port.

8.5 Configuring the RS-232 Serial Port

The RS-232 serial port implements the RS-232 communication standard. This port is always enabled. The RS-232 parameters are 8 data bits, one stop bit, and no parity. The baud rate is user-selected. The physical port is a 9-pin D connector.

To configure the port, use the following to open the RS-232 configuration screen:

1. Press the MENU key.
2. Select the SYSTEM MENU (F5) function key
3. Select the REMOTE INTERFACE (F2) function key
4. Select the SERIAL (F1) function key

The RS-233 configuration settings are BAUD RATE and LINEFEED. Configure these settings as needed.

8.6 Configuring the IEEE-488 Port

The IEEE-488 port implements a common standard parallel instrument interface bus. The port is disabled by default and must be enabled to be used. The user may specify the bus address. It provides the following IEEE-488 defined capabilities: SH1, AH1, T6, TE0, L4, LE0, SR1, RL0, PP0, DC1, DT0, C0, E2.

The IEEE-488 configuration settings are PORT ENABLE, ADDRESS, and TERMINATION. To make changes to these settings, use the following steps to go to the IEEE-488 configuration screen:

1. Press the MENU key.
2. Select the SYSTEM MENU (F5) function key
3. Select the REMOTE INTERFACE (F2) function key
4. Select the IEEE-488 (F4) function key

To use the port, ensure PORT ENABLE is set to ON (Enable) and set ADDRESS to an address that is not being used by another device on the IEEE-488 bus. The address may be set to a number between 1 and 30. The default address is 22. Always press the ENTER key after changing the address.

TERMINATION determines if a carriage return character (ASCII code 13) or linefeed character (ASCII code 10) terminates a response. The default option is LINEFEED. An IEEE-488 EOI message also accompanies the final character of every transmission.

The IEEE-488 port accepts either or any combination of, a linefeed, carriage return, or EOI as a terminator.

The CLEAR INTERFACE (F1) function key is used to clear the input and output buffers and reset the IEEE-488 interface, just as if the IFC or SDC control message was received.

8.7 Interface Commands

An alphabetical listing of the commands implemented by the Super-Thermometer is shown in Table 19 on page 70. These commands can be used with all of the remote operation ports. An example and description of each command is included following the Remote Operations Command table.

8.7.1 Command Syntax

The Super-Thermometer accepts commands that set parameters, execute functions or respond with requested data. Commands are in the form of strings of ASCII-encoded characters. Commands consist of a command header and, if necessary, parameter data. All commands must be terminated with either a carriage return (ASCII 0D hex or 13 decimal) or new line character (ASCII 0A hex or 10 decimal). Letter characters in commands are not case sensitive.

Command headers consist of one or more mnemonics separated by colons (:). Mnemonics use letter characters and possibly numeric digits as well. Commands as published use abbreviated words for mnemonics. Only the first three or four characters of each word in a received command are recognized, and subsequent letters are ignored. This allows a user to use the full word if desired, for instance “FETCH?” instead of “FETC?”. A mnemonic may end with a numeric suffix that specifies one of a set of independent function blocks such as input channel data paths. If a numeric suffix is omitted when a particular block must be specified, an error is generated in the error queue (“Header suffix out of range”).

Query commands are commands that request data in response. Query commands have a question mark (?) immediately following the command header. Some commands require parameter data to specify values for one or more parameters. The command header is separated from the parameter data by a space (ASCII 20 hex or 32 decimal). Multiple parameters, when required, are separated by a comma (,).

This product does not support compound commands (multiple commands per line separated with semicolons). All commands are sequential: the execution of each command and any associated response is completed before any subsequent command is processed.

Some commands may be password-protected, so that the associated setting cannot be changed without first issuing the password access enable command (SYST:PASS:CEN). Some commands may conditionally be password-protected, depending on the associated group password protection setting. The level of password protection is so indicated in the description for each command, unless the command is never protected. Reading a setting is always allowed.

In the commands lists and descriptions that follow, brackets [] indicate optional usage. For a <boolean> parameter, “0” or “1” is accepted, or alternately “OFF” or “ON”; a corresponding response to a query is either “0” or “1” only. Many parameters may be given as “DEF”, “MIN”, or “MAX” to set the setting to its default, minimum, or maximum value respectively. A setting’s default, minimum, or maximum value may be determined using the query form of the command and adding a parameter “DEF”, “MIN”, or “MAX” respectively.

8.7.2 List of Commands

The following table lists the commands in alphabetical order.

Table 19 Report Operation Commands

Command	Function	Associated Setting or Function (screen)
*CLS	Clears all status registers and the error queue	
*ESE	Sets the Standard Event Status Enable Register	
*ESR?	Reads and clears the Standard Event Status Register	
*IDN?	Reads the product information	
*RST	Resets operating settings to defined values	
*SRE	Sets the Service Request Enable Register	
*STB?	Reads the Status Byte Register	

Command	Function	Associated Setting or Function (screen)
CAL:DATE	Sets the instrument's date of calibration	Calibration Date (Calibration Parameters)
CAL:PAR:LIN<n>	Sets a calibration linearity correction parameter	Linearity C<n> (Calibration Parameters)
CAL:PAR:RES	Sets the calibrated resistance of an internal reference resistor	— Ω Resistor (Calibration Parameters)
CAL:PAR:ZERO	Sets the calibration zero correction parameter	Zero Correction (Calibration Parameters)
CALC<n>:AVER:ALL?	Reads a channel's statistical values	(Main Screen)
CALC<n>:AVER:AVER?	Reads a channel's statistical mean	Mean (Main Screen)
CALC<n>:AVER:CLEA	Clears a channel's statistics	RESET STATISTICS (Main Screen)
CALC:AVER:COUN	Sets the statistics Sample Count setting	Sample Count (Statistics Settings)
CALC<n>:AVER:MAX?	Reads a channel's statistical maximum	Maximum (Main Screen)
CALC<n>:AVER:MIN?	Reads a channel's statistical minimum	Minimum (Main Screen)
CALC<n>:AVER:SDEV?	Reads a channel's statistical sample standard deviation	Std Dev (Main Screen)
CALC<n>:AVER:SEM?	Reads a channel's statistical standard error of the mean	SE of Mean (Main Screen)
CALC<n>:AVER:SPR?	Reads a channel's statistical spread	Spread (Main Screen)
CALC<n>:AVER:SSIZ?	Reads a channel's statistical sample size	N (Main Screen)
CALC:AVER:TCON	Sets the Statistics Mode setting	Statistics Mode (Statistics Settings)
CALC:DELT:CHAN	Sets the Delta Channel setting	Delta Channel (Statistics Settings)
CALC<n>:DELT:DATA?	Reads a channel's delta result	Delta (Main Screen)
CALC:DELT:MODE	Sets the Delta Mode setting	Delta Mode (Statistics Settings)
CALC:DELT:OFFS	Sets the Delta Offset setting	Delta Offset (Statistics Settings)
CALC<n>:TYPE	Sets the channel's Calculation setting	Calculation (Channel Settings)
DATA:REC:ALL	Sets the data recording Record Statistics setting	Record Statistics (Recording Settings)
DATA:REC:FILE	Sets the data recording USB File setting	USB File (Recording Settings)
DATA:REC:MEM	Sets the data recording Memory Device setting	Memory Device (Recording Settings)
DATA:REC[:STAT]	Enables data recording	START/STOP RECORDING (Main Screen)
DISP:ALER:CLEA?	Clears any alert message that is active	CLEAR MESSAGE (Main Screen)
DISP:ALER[:READ]?	Reads the display alert message	(Main Screen)
DISP:DATE:FORM	Sets the display Date Format setting	Date Format (Display Settings)
DISP:DEC:FORM	Sets the display Decimal setting	Decimal (Display Settings)
DISP:FIEL:FEED<n>?	Reads a statistics field setting of the visible statistics fields memory set	(Main Screen)
DISP:FIEL:MEM[?] <n>	Reads or sets the statistics fields memory set for display	Recall Memory (Field Settings)
DISP:FIEL:MEM<n>:FEED <n>[?] <s>	Reads or sets a statistics field setting of a statistics fields memory set	Field <n> (Field Settings)
DISP:LANG	Sets the display Language setting	Language (Display Settings)
DISP:TEMP:DIG	Sets the display Temperature Resolution setting	Temperature Resolution (Display Settings)
DISP:WARN:DUE	Sets the display Rs Due Warning enable	Rs Due Warning (Display Settings)
DISP:WARN:ITS	Sets the display ITS-90 Subrange Warning enable	ITS-90 Subrange Warning (Display Settings)
FETC?	Reads a channel's latest measurement	

1594A/1595A Super-Thermometer

Interface Commands

Command	Function	Associated Setting or Function (screen)
INIT:CONT	Starts or stops measurement	START/STOP MEASURING (Main Screen)
INIT:STOP:BEEP	Sets the stop timer's Timer Beep setting	Stop Timer Enable (Timing Settings)
INIT:STOP:DUR	Sets the stop timer's Timer Duration setting	Stop Timer Duration (Timing Settings)
INIT:STOP[:STAT]	Sets the Stop Timer Enable	Stop Timer Enable (Timing Settings)
INIT:STOP:TIME?	Reads the stop timer's time remaining	Stop Timer time remaining (Main Screen)
INP<n>:CURR	Sets a channel's Sensing Current setting	Sensing Current (Channel Settings)
INP<n>:CURR:DATA?	Reads a channel's actual sensing current	
INP<n>:CURR:STAN	Sets a channel's Standby Current enable	Standby Current (Channel Settings)
INP:PROB:ADD	Adds a new probe definition to the Probe Library	ADD PROBE (Probe Menu)
INP:PROB:COUN?	Reads the number of probe definitions in the Probe Library	
INP:PROB:DEL	Deletes a probe definition from the Resistor Library	DELETE PROBE (Manage Probes)
INP:PROB:FIRS?	Reads the ID of the first probe in the Probe Library	
INP<n>:PROB:IDEN	Assigns a probe definition to the channel	ASSIGN PROBE (Channel Menu)
INP:PROB:NEXT?	Reads the ID of the next probe in the Probe Library	
INP:PROB:PAR	Sets the value of a setting in a resistor definition	EDIT PROBE (Probe Menu)
INP:PROB:TEST?	Reads the temperature calculated from resistance using the probe definition	TEST CALCULATION (Edit Probe)
INP:REAR<n>:RS:IDEN	Sets the reference resistor assigned to a rear reference resistor input	ASSIGN RESISTOR (Set Up Rs)
INP:RS:ADD	Adds a new resistor definition to the Resistor Library	ADD RESISTOR (Define Resistor)
INP:RS:COUN?	Reads the number of resistor definitions in the Resistor Library	
INP:RS:DEL	Delete the resistor ID from the Resistor Library	DELETE RESISTOR (Manage Resistors)
INP:RS:FIRS?	Reads the ID of the first resistor in the Resistor Library	
INP<n>:RS:IDEN	Sets the reference resistor assigned to a front reference resistor input	ASSIGN RESISTOR (Set Up Rs)
INP:RS:NEXT?	Reads the ID of the next resistor in the Resistor Library	
INP:RS:OVEN:STAB	Reads the oven stable condition	
INP:RS:PAR	Sets the value of a setting in a resistor definition	EDIT RESISTOR (Define Resistor)
INP<n>:RS:ROUT	Sets a channel's Reference Resistor (Rs) setting	
ROUT:CLOS	Selects one channel for measurement	
ROUT:CLOS:STAT?	Returns the channel number of whatever channel is actively being measured	Active Channel (Main Screen)
ROUT:SCAN	Enables channels for scanning	
ROUT:SCAN:ADD	Adds channels to the scan list	
ROUT:SCAN:ALT	Sets the scan Alternate Reference setting	Alternate Reference (Scan Settings)
ROUT:SCAN:DEL	Removes channels from the scan list	
ROUT:SCAN:REF	Sets the scan Reference Channel setting	Reference Channel (Scan Settings)
ROUT:SCAN:REP	Sets the scan Repeat Count setting	Repeat Count (Scan Settings)
ROUT:SCAN:STAT	Sets the Scan Enable setting	Scan Enable (Scan Settings)
SENS:APER	Sets the measurement time and Display Interval	Display Interval (Timing Settings)

Command	Function	Associated Setting or Function (screen)
SENS:APER:PRES	Sets the measurement timing settings to preset values	PRESET PRECISION PRESET FAST PRESET LONG (Timing Settings)
SENS:APER:SAMP	Sets the measurement Sample Period	Sample Period (Timing Settings)
SENS:AVER1	Sets the Average Enable for the sample average	Average Enable (Timing Settings)
SENS:AVER2	Sets the digital filter's Filter Enable	Filter Enable (Digital Filter)
SENS:AVER2:COUN	Sets the digital filter's Average Count setting	Average Count (Digital Filter)
SENS:AVER2:CLEA	Clears the digital filter buffer	CLEAR FILTER f-key (Digital Filter)
SENS<n>:DATA?	Reads a channel's latest resistance measurement	
SENS<n>:RRAT:DATA?	Reads a channel's latest resistance ratio measurement	
STAT:OPER?	Reads and clears the Operation Status Event Register	
STAT:OPER:COND?	Reads the Operation Status Condition Register	
STAT:OPER:ENAB	Sets the Operation Status Enable Register	
STAT:PRES	Sets the status enable registers to defined states	
STAT:QUES?	Reads and clears the Questionable Status Event Register	
STAT:QUES:COND?	Reads the Questionable Status Condition Register	
STAT:QUES:ENAB	Sets the Questionable Status Enable Register	
SYST:BEEP	Produces an immediate beep from the speaker	
SYST:BEEP:KEY	Sets the Keypad Beep setting	Keypad Beep (Display Settings)
SYST:BEEP:ALER	Sets the Alert Beep setting	Alert Beep (Display Settings)
SYST:CODE:VERS?	Read the firmware code version	
SYST:COMM:GPIB:ADDR	Sets the IEEE-488 port's Address setting	Address (IEEE-488 Port)
SYST:COMM:GPIB[:STAT]	Sets the IEEE-488 port's Port Enable setting	Port Enable (IEEE-488 Port)
SYST:COMM:GPIB:TERM	Sets the IEEE-488 port's Termination setting	Termination (IEEE-488 Port)
SYST:COMM:SER:BAUD	Sets the serial port Baud Rate setting	Baud Rate (Serial Port)
SYST:COMM:SER:LIN	Sets the serial port Linefeed setting	Linefeed (Serial Port)
SYST:COMM:SOCK:ADDR	Sets the network port's IP Address setting	IP Address (Network Port)
SYST:COMM:SOCK:CONT	Sets the network port's Control Enable setting	Control Enable (Network Port)
SYST:COMM:SOCK:DHCP	Sets the network port's DHCP Enable	DHCP Enable (Network Port)
SYST:COMM:SOCK:GAT	Sets the network port's Gateway setting	Gateway (Network Port)
SYST:COMM:SOCK:KEEP	Sets the network port's keep-alive timeout	
SYST:COMM:SOCK:MAC?	Reads the network port's Hardware MAC address	Hardware MAC (Network Port)
SYST:COMM:SOCK:MASK	Sets the network port's Subnet Mask setting	Subnet Mask (Network Port)
SYST:COMM:SOCK:NAME	Sets the network port's Host Name	Host Name (Network Port)
SYST:COMM:USB[:STAT]	Sets the USB port's Port Enable	Port Enable (USB Port)
SYST:CONF:CHAN?	Reads the number of available channels	
SYST:CONF:SCAN?	Reads the model number of an attached scanner	
SYST:DATE	Sets the Date of the system clock	Date (Time and Date)
SYST:ERR?	Reads the next error in the error queue	
SYST:KLOC	Sets the front-panel key lock	
SYST:PASS:CDIS	Disables access to password-protected settings	
SYST:PASS:CEN	Enables access to password-protected settings	
SYST:PASS:CEN:STAT?	Returns the password access state	
SYST:PASS:GROU:MEAS	Sets the password Measure Protection setting	Measure Protection (Password)
SYST:PASS:GROU:PROB	Sets the password Probe Protection setting	Probe Protection (Password)

Command	Function	Associated Setting or Function (screen)
SYST:PASS:GROU:RES	Sets the password Resistor Protection setting	Resistor Protection (Password)
SYST:PASS:GROU:TIME	Sets the password Time/Date Protection setting	Time/Date Protection (Password)
SYST:PASS:NEW	Changes the password	Password (Password)
SYST:PON:MIN?	Reads the time in minutes since power-on	
SYST:TIME	Sets the Time of the system clock	Time (Time and Date)
SYST:TIME:DAYL	Sets the Daylight Saving automatic adjust setting	Daylight Saving (Time and Date)
TEST:CURR:CONF	Sets the configuration of the sensing current test	CURRENT TEST (Calibration)
TEST:CURR[:STAT]	Starts or stops the sensing current test	CURRENT TEST (Calibration)
TEST:LIN:ABOR	Cancels a linearity self-test	LINEARITY TEST (Calibration)
TEST:LIN:INIT	Starts linearity calibration	LINEARITY TEST (Calibration)
TEST:LIN:PAR?	Reads the suggested linearity calibration parameters	LINEARITY TEST (Calibration)
TEST:LIN:REP<n>?	Reads the linearity self-test report	LINEARITY TEST (Calibration)
TEST:LIN:STAT?	Reads the state of the linearity self-test	LINEARITY TEST (Calibration)
TEST:LIN:TIME?	Reads the time remaining of the linearity self-test	LINEARITY TEST (Calibration)
TEST:LIN:TOL<n>?	Reads a linearity calibration error tolerance	LINEARITY TEST (Calibration)
TEST:SYST:ABOR	Cancel a system self-test	SYSTEM TEST (Calibration)
TEST:SYST:INIT	Initiate a system self-test	SYSTEM TEST (Calibration)
TEST:SYST:REP<n>?	Reads the report from a system self-test	SYSTEM TEST (Calibration)
TEST:SYST:STAT?	Read the completion state of the system self-test	SYSTEM TEST (Calibration)
UNIT:TEMP	Set the temperature Unit	Unit (Temperature Unit)

8.7.3 Descriptions of Commands

The function of each command as well as an example of each is listed below.

8.7.3.1 *CLS

Clears all status registers and the error queue. Specifically, this command clears the Standard Event Status Register (see Section 8.7.3.3, *ESR?, on page 74), Operation Status Event Register (see Section 8.7.3.89, STAT:OPER?, on page 94), Questionable Status Event Register (see Section 8.7.3.92, STAT:QUES?, on page 94), and system error queue (see Section 8.7.3.116, SYST:ERR?, on page 98). The Status Byte Register (see Section 8.7.3.7, *STB?, on page 76) is updated to show the new state of the registers.

8.7.3.2 *ESE <value>

Example command: *ESE 16

Query form: *ESE?

Sets the Standard Event Status Enable Register. This mask register determines which corresponding bits of the Standard Event Status Register (see Section 8.7.3.3, *ESR?, on page 74) affect the ESB summary message (bit 5) of the Status Byte Register.

8.7.3.3 *ESR?

Example response: 160

Reads and clears the Standard Event Status Register. This indicates any of several events defined by the IEEE-488.2 standard and which are listed in the following table. Reading the Standard Event Status Register clears it. The register is also cleared by the *CLS command.

Bit	Event
0	OPC, Operation Complete
1	Request control (not used)
2	Query error
3	Device dependent error
4	Execution error
5	Command error
6	User request (not used)
7	Power on

8.7.3.4 *IDN?

Example response: FLUKE,1594,A9C111,1.10/1.00

Reads the instrument information.

The response is given in the following format:

<manufacturer>,<model number>,<serial number>,<version numbers>

8.7.3.5 *RST

Sets operating settings to default states.

The following settings are affected:

- Any self-test in progress is canceled
- Measurement enable is set to OFF
- Channel 2 enable is set to ON, all other channels OFF
- Scan Enable is set to ON
- Repeat Count is set to 1
- Alternate Reference is set to OFF
- Reference Channel is set to channel 2
- Timing settings are preset to NORMAL presets
- Stop Timer Enable is set to OFF
- Timer Duration is set to 3600 s
- Timer Beep is set to ON
- Filter Enable is set to ON
- Time Window is set to 60
- Statistics Mode is set to UNLIMITED
- Sample Count is set to 100
- Delta Mode is set to OFFSET
- Delta Offset is set to 0.
- Delta Channel is set to channel 2
- Unit is set to °C
- The key lock setting is set to off
- Statistics are reset

Not affected are channel settings other than enable, probe definitions, resistor definitions, recording settings, display settings other than Unit, remote interface settings, time and date, password settings, and calibration settings.

8.7.3.6 *SRE <value>

Example command: *SRE 16

Query form: *SRE?

Sets the Service Request Enable register. This mask register determines which corresponding bits of the Status Byte Register (see Section 8.7.3.7, *STB?, on page 76) affect the MSS master summary bit (bit 6) of the Status Byte Register and generate a service request from the IEEE-488 port.

8.7.3.7 *STB?

Example response: 16

Reads the Status Byte Register. This indicates any of several events defined by the IEEE-488.2 and SCPI standards and which are listed in the following table. Reading the Status Byte Register does not affect it.

Bit	Condition
0	(not used)
1	(not used)
2	Error
3	Questionable status
4	Message available
5	Event status
6	Master summary status
7	Operation status

8.7.3.8 CAL:DATE <year>,<month>,<day>

Example command: CAL:DATE 2009,8,21

Query form: CAL:DATE?

Password protection: unconditional

Sets the instrument's date of calibration.

8.7.3.9 CAL:PAR:LIN<n> <value>

Query form: CAL:PAR:LIN1?

Password protection: unconditional

Sets a calibration Linearity C<n> parameter.

These settings may be used to apply a linearity correction to the measurement circuit.



IMPORTANT: Calibration parameters should not be changed except as part of the Super-Thermometer calibration procedure performed by a qualified service technician.

8.7.3.10 CAL:PAR:RES<n> <value>

Query form: CAL:PAR:RES<n>?

Password protection: unconditional

Sets the calibrated resistance of an internal reference resistor. Suffix <n> specifies the resistor; 1: 1 Ω; 2: 10 Ω; 3: 25 Ω; 4: 100 Ω; 5: 10 kΩ.

IMPORTANT: Calibration parameters should not be changed except as part of the Super-Thermometer calibration procedure performed by a qualified service technician.

8.7.3.11 CAL:PAR:ZERO <value>

Query form: CAL:PAR:ZERO?

Password protection: unconditional

Sets the calibration Zero Correction parameter.

This setting may be used to apply a zero correction to the measurement circuit.



IMPORTANT: Calibration parameters should not be changed except as part of the Super-Thermometer calibration procedure performed by a qualified service technician.

8.7.3.12 CALC<n>:AVER:ALL?

Example command: CALC3:AVER:ALL?

Example response: 231.928581,0.000488,0.000212,231.92862,231.928479,23

Example response: 231.928581,,,231.928581,231.928581,1

Example response: ,,,,0

Reads a channel's statistical mean, standard deviation, standard error of the mean, maximum, minimum, and sample size.

Suffix <n> is the channel number: 1 through 4 for the corresponding front channel input, 5 through 14 for channels of the first attached scanner, and 15 through 24 for channels of the second attached scanner.

The response is given in the following format:

<mean>,<std. dev.>,<std. error>,<max.>,<min.>,<N>

If a value is invalid or not available, the field is left empty in the response (the associated field separator comma remains).

The statistical values have the same unit as the measurement returned by the FETC? command. If the calculation is temperature, the unit of measurement is determined by the Unit setting (see Section 5.7.4.5, TEMPERATURE UNIT (F5), on page 50).

8.7.3.13 CALC<n>:AVER:AVER?

Example command: CALC3:AVER:AVER?

Example response: 231.928581

Reads a channel's statistical mean (see Section 5.7.4.2, FIELD SETTINGS (F2), on page 48).

Suffix <n> is the channel number: 1 through 4 for the corresponding front channel input, 5 through 14 for channels of the first attached scanner, and 15 through 24 for channels of the second attached scanner.

The returned value has the same units as the measurement returned by the FETC? command. If the calculation is temperature, the unit of measurement is determined by the Unit setting see Section 5.7.4.5, TEMPERATURE UNIT (F5), on page 50).

If no result is available, no response is returned and error -230, "Data corrupt or stale" is generated in the error queue.

8.7.3.14 CALC[<n>]:AVER:CLEAR

Example command: CALC:AVER:CLEAR

Clears a channel's statistics.

Suffix <n> is the channel number: 1 through 4 for the corresponding front channel input, 5 through 14 for channels of the first attached scanner, and 15 through 24 for channels of the second attached scanner. If the suffix number is omitted, statistics for all channels are cleared. This is equivalent to pressing the RESET STATISTICS function key in the Main Screen.

The *RST command also clears the statistics for all channels.

8.7.3.15 CALC:AVER:COUN <value>

Example command: CALC:AVER:COUNT 50

Query form: CALC:AVER:COUN?

Alternate parameter: DEF, MIN, MAX

Sets the statistics Sample Count setting.

Parameter <value> is the maximum number of samples in the moving window when the Statistics Mode setting is LIMITED (see Section 8.7.3.22, CALC:AVER:TCON NORM|MOV, on page 79). The range is 1 through 100 and the default is 100.

The *RST command sets Sample Count to 100.

8.7.3.16 CALC<n>:AVER:MAX?

Example command: CALC3:AVER:MAX?

Example response: 231.928833

Reads a channel's statistical maximum (see Section 5.7.4.2, FIELD SETTINGS (F2), on page 48).

Suffix <n> is the channel number: 1 through 4 for the corresponding front channel input, 5 through 14 for channels of the first attached scanner, and 15 through 24 for channels of the second attached scanner.

The returned value has the same units as the measurement returned by the FETC? command. If the calculation is temperature, the unit of measurement is determined by the Unit setting (see Section 5.7.4.5, TEMPERATURE UNIT (F5), on page 50).

If no result is available, no response is returned and error -230, "Data corrupt or stale" is generated in the error queue.

8.7.3.17 CALC<n>:AVER:MIN?

Example command: CALC3:AVER:MIN?

Example response: 231.928207

Reads a channel's statistical minimum (see Section 5.7.4.2, FIELD SETTINGS (F2), on page 48).

Suffix <n> is the channel number: 1 through 4 for the corresponding front channel input, 5 through 14 for channels of the first attached scanner, and 15 through 24 for channels of the second attached scanner.

The returned value has the same units as the measurement returned by the FETC? command. If the calculation is temperature, the unit of measurement is determined by the Unit setting (see Section 5.7.4.5, TEMPERATURE UNIT (F5), on page 50).

If no result is available, no response is returned and error -230, "Data corrupt or stale" is generated in the error queue.

8.7.3.18 CALC<n>:AVER:SDEV?

Example command: CALC3:AVER:SDEV?

Example response: 0.000144

Reads a channel's statistical sample standard deviation (see Section 5.7.4.2, FIELD SETTINGS (F2), on page 48).

Suffix <n> is the channel number: 1 through 4 for the corresponding front channel input, 5 through 14 for channels of the first attached scanner, and 15 through 24 for channels of the second attached scanner.

The returned value has the same units as the measurement returned by the FETC? command. If the calculation is temperature, the unit of measurement is determined by the Unit setting (see Section 5.7.4.5, TEMPERATURE UNIT (F5), on page 50).

The standard deviation is available if at least four measurements have been acquired from the channel. If no result is available, no response is returned and error -230, "Data corrupt or stale" is generated in the error queue.

8.7.3.19 CALC<n>:AVER:SEM?

Example command: CALC3:AVER:SEM?

Example response: 0.000039

Reads a channel's statistical standard error of the mean (see Section 5.7.4.2, FIELD SETTINGS (F2), on page 48).

Suffix <n> is the channel number: 1 through 4 for the corresponding front channel input, 5 through 14 for channels of the first attached scanner, and 15 through 24 for channels of the second attached scanner.

The returned value has the same units as the measurement returned by the FETC? command. If the calculation is temperature, the unit of measurement is determined by the Unit setting (see Section 5.7.4.5, TEMPERATURE UNIT (F5), on page 50).

The standard error of the mean is available if at least four measurements have been acquired from the channel. If no result is available, no response is returned and error -230, "Data corrupt or stale" is generated in the error queue.

8.7.3.20 CALC<n>:AVER:SPR?

Example command: CALC3:AVER:SPREAD?

Example response: 0.000626

Reads a channel's statistical spread (see Section 5.7.4.2, FIELD SETTINGS (F2), on page 48).

Suffix <n> is the channel number: 1 through 4 for the corresponding front channel input, 5 through 14 for channels of the first attached scanner, and 15 through 24 for channels of the second attached scanner.

The returned value has the same units as the measurement returned by the FETC? command. If the calculation is temperature, the unit of measurement is determined by the Unit setting (see Temperature Unit (F5) in the Display Menu).

If no result is available, no response is returned and error -230, "Data corrupt or stale" is generated in the error queue.

8.7.3.21 CALC<n>:AVER:SSIZ?

Example command: CALC3:AVER:SSIZE?

Example response: 40

Reads a channel's statistical sample size (see Section 5.7.4.2, FIELD SETTINGS (F2), on page 48).

Suffix <n> is the channel number: 1 through 4 for the corresponding front channel input, 5 through 14 for channels of the first attached scanner, and 15 through 24 for channels of the second attached scanner.

8.7.3.22 CALC:AVER:TCON NORM|MOV

Query form: CALC:AVER:TCON?

Alternate parameter: DEF

Sets the Statistics Mode setting (see Section 5.7.4.3, STATISTICS SETTINGS (F3), on page 49).

If the parameter is NORM (normal), the sample size is unlimited; the sample set accumulates until the statistics are cleared. If the parameter is MOV (moving window), the sample size is limited, and once the sample size reaches the Sample Count value, earliest samples are removed from the sample set when new samples are added.

The *RST command sets Statistics Mode to the default setting which is NORM (UNLIMITED).

8.7.3.23 CALC:DELT:CHAN <channel>

Example command: CALC:DELT:CHAN 1

Query form: CALC:DELT:CHAN?

Sets the Delta Channel setting (see Section 5.7.4.3, STATISTICS SETTINGS (F3), on page 49).

Parameter <channel> is the channel number to use as the reference, which may be 1 through 4 for the corresponding front channel input, 5 through 14 for channels of the first attached scanner, and 15 through 24 for channels of the second attached scanner.

This setting is only meaningful when Delta Mode is set to CHANNEL.

The *RST command sets Delta Channel to 2.

8.7.3.24 CALC<n>:DELT:DATA?

Example command: CALC3:DELT:DATA?

Example response: 0.104428

Reads a channel's delta result (see Section 5.7.4.2, FIELD SETTINGS (F2), on page 48).

Suffix <n> is the channel number: 1 through 4 for the corresponding front channel input, 5 through 14 for channels of the first attached scanner, and 15 through 24 for channels of the second attached scanner.

No result will be available if no measurement has been acquired on a designated Delta Channel or if the two measurements have different units. If no result is available, no response is returned and error -230, "Data corrupt or stale" is generated in the error queue.

8.7.3.25 CALC:DELT:MODE OFFS|CHAN

Query form: CALC:DELT:MODE?

Alternate parameter: DEF

Sets the Delta Mode setting (see Section 5.7.4.3, STATISTICS SETTINGS (F3), on page 49).

If the parameter is OFFS (OFFSET), the delta result is calculated by subtracting the Delta Offset setting's value from the channel's measurement. If the parameter is CHAN (CHANNEL), the delta result is calculated by subtracting the measurement from the channel determined by the Delta Channel setting from the channel's measurement.

The *RST command sets Delta Mode to the default setting which is OFFS.

8.7.3.26 CALC:DELT:OFFS <value>

Query form: CALC:DELT:OFFS?

Sets the Delta Offset setting (see Section 5.7.4.3, STATISTICS SETTINGS (F3), on page 49).

This setting is only meaningful when Delta Mode is set to OFFSET.

The *RST command sets Delta Offset to the default value which is 0.

8.7.3.27 CALC<n>:TYPE TEMP|RES|RAT

Query form: CALC<n>:TYPE?

Alternate parameter: DEF

Sets the channel's Calculation setting.

Suffix <n> specifies the channel number: 1 through 4 for the corresponding front channel input, 5 through 14 for channels of the first attached scanner, and 15 through 24 for channels of the second attached scanner. The default setting may depend on the probe and reference resistor settings.

8.7.3.28 DATA:REC:ALL <boolean>

Query form: DATA:REC:ALL?

Alternate parameter: DEF

Sets the data recording Record Statistics setting (see Section 5.7.3.4.1, RECORDING SETTINGS (F1), on page 42). The default is ON.

8.7.3.29 DATA:REC:FILE <name>

Query form: DATA:REC:FILE?

Sets the data recording USB File name (see Section 5.7.3.4.1, RECORDING SETTINGS (F1), on page 42).

8.7.3.30 DATA:REC:MEM INT|USB|BOTH

Query form: DATA:REC:MEM?

Sets the data recording Memory Device (see Section 5.7.3.4.1, RECORDING SETTINGS (F1), on page 42).

8.7.3.31 DATA:REC[:STAT] <boolean>

Query form: DATA:REC?

Starts or stops recording. This is equivalent to pressing the START RECORDING or STOP RECORDING function key in the Main Screen. A <boolean> parameter value 1 enables recording; 0 disables recording.

The *RST command has no effect on this setting.

8.7.3.32 DISP:ALER:CLEA

Clears any alert message that is active.

8.7.3.33 DISP:ALER[:READ]?

Example response: 1,“Maximum temperature exceeded”

Reads the active alert message. The response given is the alert message number and description, comma-separated and with the description enclosed in quotation marks. If no alert message is active, the response is 0,“No alert”. The following table lists the possible responses:

Alert	Cause
0;“No alert”	No alert message is active.
1;“Maximum temperature exceeded”	A measured temperature exceeds the limit defined for a probe.
2;“ITS-90 subrange exceeded”	A measured temperature is outside the ITS-90 subranges defined for a probe.
3;“Resistor due for calibration”	A defined resistor in the Resistor Library is past due for calibration.

The active alert message may be cleared using the DISP:ALER:CLEA command.

8.7.3.34 DISP:DATE:FORM YMD|DMY|MDY

Query form: DISP:DATE:FORM?

Alternate parameter: DEF

Sets the display Date Format setting (see Section 5.7.4.1, USER SETTINGS (F1), on page 47). The default setting is YMD.

8.7.3.35 DISP:DEC:FORM PER|COMM

Query form: DISP:DATE:FORM?

Alternate parameter: DEF

Sets the display Decimal setting (see Section 5.7.4.1, USER SETTINGS (F1), on page 47). The default setting is PER.

8.7.3.36 DISP:FIEL:FEED<n>?

Example command: DISP:FIEL:FEED4?

Example response: DEF

Reads a statistics field setting of the visible statistics fields memory set (see Section 5.7.4.2, FIELD SETTINGS (F2), on page 48).

Suffix <n> is the field number, which may be 1 through 4. The response will be one of the following: MEAN, SDEV, SEM, MAX, MIN, SPR, N, DELT, RES, RAT, TIME, or DATE.

8.7.3.37 DISP:FIEL:MEM <n>

Example command: DISP:FIEL:MEM 4

Query form: DISP:FIEL:MEM<n>?

Alternate parameter: MIN, MAX, DEF

Reads or sets a statistics fields memory set for display (see Section 5.7.4.2, FIELD SETTINGS (F2), on page 48).

The parameter <n> may be a number from 1 to 4.

8.7.3.38 DISP:FIEL:MEM<n1>:FEED<n2> <feed>

Example command: DISP:FIEL:MEM4:FEED4 TIME

Query form: DISP:FIEL:MEM<n1>:FEED<n2>?

Alternate parameter: DEF

Reads or sets a statistics field setting of a statistics fields memory set (see Section 5.7.4.2, FIELD SETTINGS (F2), on page 48).

Suffix <n1> is the memory set number, which may be 1 through 4. Suffix <n2> is the field number, which may be 1 through 4. The parameter <feed> may be one of the following: MEAN, SDEV, SEM, MAX, MIN, SPR, N, DELT, RES, RAT, TIME, or DATE.

8.7.3.39 DISP:HELP <boolean>

Query form: DISP:HELP?

Sets the display Start-up Help Screen enable.

This setting determines whether the Start-up Help Screen appears at power-on. By default it is 1 and the Start-up Help Screen appears each time the instrument is powered on. If the setting is changed to 0, the Start-up Help Screen will no longer appear.

8.7.3.40 DISP:LANG ENGLISH|CHINESE|JAPANESE|SPANISH|GERMAN|FRENCH|RUSSIAN

Query form: DISP:LANG?

Alternate parameter: DEF

Sets the display Language setting (see Section 5.7.4.1, USER SETTINGS (F1), on page 47). The default setting is ENGLISH.

8.7.3.41 DISP:TEMP:DIG <digits>

Query form: DISP:TEMP:DIG?

Alternate parameter: DEF, MIN, MAX

Sets the display Temperature Resolution setting (see Section 5.7.4.1, USER SETTINGS (F1), on page 47).

Parameter <digits> specifies the number of decimal places. The range is 1 to 6 and the default is 5.

8.7.3.42 DISP:WARN:DUE <boolean>

Query form: DISP:WARN:DUE?

Alternate parameter: DEF

Sets the display Rs Due Alert enable (see Section 5.7.4.1, USER SETTINGS (F1), on page 47). The default setting is OFF.

8.7.3.43 DISP:WARN:ITS <boolean>

Query form: DISP:WARN:ITS?

Alternate parameter: DEF

Sets the display ITS-90 Subrange Alert enable (see Section 5.7.4.1, USER SETTINGS (F1), on page 47). The default setting is ON.

8.7.3.44 FETC? <channel>

Example command: FETCH? 4

Example response: 231.92811,C,4,2009-03-23 14:33:20

Reads a channel's latest measurement.

The <channel> parameter may be 1 through 4 for corresponding front channel inputs, 5 through 14 for channels of a first attached scanner, or 15 through 24 for channels of a second attached scanner. If the <channel> parameter is omitted, the latest measurement regardless of channel is returned.

If a measurement is available, the response is given in the following format:

<measurement value>,<unit>,<channel number>,<date and time>

<measurement value> is the value of the measurement. It may be a temperature, resistance, or resistance ratio. The number of decimal places depends on the measured parameter. Trailing zeros are omitted.

<unit> may be "C", "F", or "K" for a temperature measurement; "O" for a resistance measurement, or "R" for a resistance ratio measurement.

<channel number> is 1 through 4 for corresponding front channel inputs, 5 through 14 for channels of a first scanner, or 15 through 24 for channels of a second scanner.

<time and date> gives the time and date of the measurement, separated by one space. The time is in 24-hour format. The date is in the format YYYY-MM-DD.

If no measurement is available, no response is returned and error code -230, "Data corrupt or stale," is generated in the error queue. The command STAT:OPER? may be used first to determine whether a new measurement has completed, and command STAT:QUES:COND? may be used to determine whether the new measurement is valid before an attempt is made to read it.

8.7.3.45 INIT:CONT <boolean>

Query form: INIT:CONT?

Starts or stops measurement. This is equivalent to pressing the START MEASUREMENT or STOP MEASUREMENT function key in the Measurement Screen. A <boolean> parameter value 1 enables measurement; 0 disables measurement.

The *RST command disables measurement.

8.7.3.46 INIT:STOP:BEEP <boolean>

Query form: INIT:STOP:BEEP?

Alternate parameter: DEF

Sets the stop timer's Audio Indication setting (see Section 5.7.3.2, TIMING SETTINGS (F2), on page 39).

The *RST command sets Timer Beep to the default option which is ON.

8.7.3.47 INIT:STOP:DUR <value>

Example command: INIT:STOP:DUR 1200

Query form: INIT:STOP:DUR?

Alternate parameter: DEF, MIN, MAX

Sets the stop timer's Timer Duration setting (see Section 5.7.3.2, TIMING SETTINGS (F2), on page 39). The value is the number of seconds. The range is 1 to 86399 and the default is 3600 (one hour).

This setting is only meaningful when Stop Timer Enable is ON.

The *RST command sets Timer Duration to 3600.

8.7.3.48 INIT:STOP[:STAT] <boolean>

Query form: INIT:STOP?

Alternate parameter: DEF

Sets the Stop Timer Enable (see Section 5.7.3.2, TIMING SETTINGS (F2), on page 39).

The *RST command sets Stop Timer Enable to the default setting which is OFF.

8.7.3.49 INIT:STOP:TIME?

Example response: 874

Reads the stop timer's time remaining.

The returned value is the time remaining in seconds. If the stop timer is disabled or measurement is not enabled, the returned value is 0.

8.7.3.50 INP<n>:CURR <current>

Example command: INP1:CURR 1

Query form: INP<n>:CURR?

Alternate parameter: DEF, MIN, MAX

Sets a channel's Sensing Current setting.

Suffix <n> specifies the channel number: 1 through 4 for the corresponding front channel input, 5 through 14 for channels of the first attached scanner, and 15 through 24 for channels of the second attached scanner.

The maximum and default values depend on the probe and reference resistor settings. The values may be read using the query form with alternate parameters MAX and DEF respectively.

The actual current may be reduced if the resistance is too high. The actual current may be read using the INP<n>:CURR:DATA? command.

8.7.3.51 INP<n>:CURR:DATA?

Reads a channel's actual sensing current. It is the sensing current that was used when the latest measurement of the channel was acquired.

8.7.3.52 INP<n>:CURR:STAN <boolean>

Query form: INP<n>:CURR:STAN?

Alternate parameter: DEF

Sets a channel's Standby Current enable.

A parameter value 1 enables the standby current. When enabled, sensing current is sourced from the channel's terminals when measurement is enabled, even if the channel is not enabled or when another channel is being scanned. The default setting is 0 (OFF).

8.7.3.53 INP:PROB:ADD <id>

Example command: INP:PROB:ADD "PRT_A46002"

Password protection: Probe Protection

Adds a new probe definition to the Probe Library. Before a probe can be assigned to a channel and temperature measured, the probe must have its definition added to the Probe Library (see Section 8.7.3.57, INP<n>:PROB:IDEN <id>, on page 85).

Parameter <id> is the ID of the new probe definition. It can contain letters, numerals, hyphens, periods, forward slashes, and underscores. It must be between one and 24 characters in length, inclusive.

If <id> is different from all other IDs in the Probe Library and space is available in the Probe Library, a new probe definition will be added and given the specified ID. The probe parameters will initially be set to default values. The command INP:PROB:PAR should be used to set the parameters.

If <id> matches the ID of a probe already in the Probe Library or the Probe Library is full, no new probe definition is added, and error -224, “Illegal parameter value” will be generated in the error queue.

8.7.3.54 INP:PROB:COUN?

Alternate parameter: MAX

Reads the number of probe definitions in the Probe Library.

8.7.3.55 INP:PROB:DEL <id>

Example command: INP:PROB:DEL “PRT_A46002”

Password protection: Probe Protection

Deletes a probe definition from the Probe Library.

Parameter <id> is the ID of the probe definition to delete. If <id> does not match the ID of any probe in the Probe Library, nothing is deleted, and error -224, “Illegal parameter value” is generated in the error queue.

If the deleted probe was assigned to a channel the channel’s probe setting is changed to undefined (see Section 8.7.3.57, INP<n>:PROB:IDEN <id>, on page 85).

8.7.3.56 INP:PROB:FIRS?

Example response: “PRT_A46002”

Reads the ID of the first probe in the Probe Library. It also resets the library index used by the INP:PROB:NEXT? command.

If the Probe Library is empty the response is an empty string, “”.

8.7.3.57 INP<n>:PROB:IDEN <id>

Example command: INP1:PROB:IDEN “PRT_A46002”

Example command: INP2:PROB:IDEN NONE

Query form: INP<n>:PROB:IDEN?

Assigns a probe definition to the channel.

Suffix <n> specifies the channel number: 1 through 4 for the corresponding front channel input, 5 through 14 for channels of the first attached scanner, and 15 through 24 for channels of the second attached scanner.

Parameter <id> must either be the ID of a probe definition in the Probe Library, or “NONE” (undefined). Enclosing quotation marks are optional. If <id> does not match the ID of a probe definition in the Probe Library, error -224, “Illegal parameter value” is generated in the error queue.

If a valid probe ID is assigned to the channel, the response to the query form is the ID of the probe enclosed in quotation marks. If the assigned probe is undefined, the response is “NONE” without quotation marks.

The channel’s Calculation setting will automatically be set to resistance if it was temperature when the channel’s assigned probe is set to NONE.

8.7.3.58 INP:PROB:NEXT?

Example response: “A71040”

Reads the ID of the next probe in the Probe Library. It also advances the library index used for the next response to the INP:PROB:NEXT? command.

If there are no more probes in the Probe Library, the response is an empty string, "".

8.7.3.59 INP:PROB:PAR <id>,<name>,<value>

Example command: INP:PROB:PAR "PRT_A46002",TYPE,PRT

Query form: INP:PROB:PAR? <id>,<name>

Example query command: INP:PROB:PAR? "PRT_A46002",TYPE

Example query response: PRT

Password protection: Probe Protection

Sets the value of a setting in a probe definition.

Parameter <id> is the ID of a probe definition in the Probe Library. The ID should be enclosed in double quotation marks. If <id> does not match the ID of a probe definition in the Probe Library, error -224, "Illegal parameter value" is generated in the error queue.

Parameter <name> specifies the setting to set. Settings and their associated names are listed in the table below (also see Section 5.7.2.3, EDIT PROBE (F3), on page 36).

Setting	<name>	<value> type or options
Type	TYPE	PRTITHERIRES
Calibration Date	CAL_DATE	string: "<yyyy>-<mm>-<dd>"
Nominal Current	NOM_CURR	decimal number
Maximum Current	MAX_CURR	decimal number
PRT type settings		
Maximum Temperature	MAX_TEMP	decimal number, dependent on Unit setting
Conversion	CONV	ITS_90IPT_100ICVD_ABCICVD_ALPHIPOLYINONE
ITS-90 conversion settings		
RTPW	RTPW	decimal number
High Subrange	HIGH_SUB	NONE 5 6 7 8 9 10 11
Low Subrange	LOW_SUB	NONE 1 2 3 4 5
ITS-90 subrange settings		
A1 – A11	A1 – A11	exponential number
B1 – B9	B1 – B9	exponential number
C1 – C5, C6, C7	C1 – C5, C6, C7	exponential number
D	D	exponential number
PT-100 conversion settings		
R0	R0	decimal number
CVD-ABC conversion settings		
R0	R0	decimal number
A	A	exponential number
B	B	exponential number
C	C	exponential number
CVD-ALPHA conversion settings		
R0	R0	decimal number
ALPHA	ALPH	exponential number
DELTA	DELT	exponential number
BETA	BETA	exponential number
Polynomial conversion settings		

C0 – C7	C0 – C7	exponential number
Thermistor type settings		
Maximum Temperature	MAX_TEMP	decimal number, dependent on Unit setting
Conversion	CONV	R_POLYIT_POLYINONE
R(T) polynomial conversion settings		
B0 – B3	B0 – B3	exponential number
T(R) polynomial conversion settings		
A0 – A3	A0 – A3	exponential number

The settings that are applicable to the probe definition depends on the Type setting and Conversion setting, and may depend on other settings also, such as an ITS-90 subrange.

Any channel that has the probe assigned to it and has Calculation setting set to temperature will have Calculation (see Section 8.7.3.27, CALC<n>:TYPE TEMP|RES|RAT, on page 80) changed to resistance when the probe's Type setting is set to resistor or the Conversion setting is set to none.

8.7.3.60 INP:PROB:TEST? <id>,<resistance>

Example command: INP:PROB:TEST? "PRT_A46002",65.449411

Example response: 419.527,C

Reads the temperature calculated from resistance using the probe definition.

Parameter <id> is the ID of a probe definition in the Probe Library. If <id> does not match the ID of a probe definition in the Probe Library, error -224, "Illegal parameter value" is generated in the error queue.

Parameter <resistance> is the resistance from which temperature is calculated.

The normal response contains the calculated temperature and the unit, separated by a comma:

<Temperature>,<unit>

The <temperature> value is converted to units determined by the Unit setting (see Section 5.7.4.5, TEMPERATURE UNIT (F5), on page 50). If the probe Type is RESISTOR or Conversion is NONE, the <resistance> parameter value is returned instead, with <unit> "O" for ohms. If a valid response cannot be returned because the given resistance is out of range or the probe definition is invalid, no response is given and error -230, "Data corrupt or stale" is generated in the error queue.

8.7.3.61 INP:REAR<n>:RS:IDEN <id>|VAR|NONE

Example command: INP:REAR1:RS:IDEN "R25_01322"

Example command: INP:REAR2:RS:IDEN NONE

Query form: INP:REAR<n>:RS:IDEN?

Example query response: "R25_01322"

Example query response: VAR

Sets the resistor definition assigned to a rear reference resistor input. (Use the command INP<n>:RS:IDEN to assign a resistor definition to a front channel input.)

Suffix <n> specifies the rear Rs input number and must be either 1 or 2.

Parameter <id> must be either the ID of a resistor definition in the Resistor Library, "VAR" (variable), or "NONE". Enclosing quotation marks are optional. If <id> does not match the ID of a resistor definition in the Resistor Library or an allowed option, error -224, "Illegal parameter value" is generated in the error queue.

If a valid resistor ID is assigned to the input, the response to the query form is the ID of the resistor enclosed in quotation marks. If the resistor assignment is variable or none, the response is "VAR" or "NONE" respectively, without quotation marks.

A channel's Calculation setting will be changed from temperature to resistance (see Section 8.7.3.27, CALC<n>:TYPE TEMP|RES|RAT, on page 80) if its Reference Resistor (Rs) setting was set to the specified input and the resistor assignment for the input is set to variable. A channel's Reference Resistor (Rs) setting will be changed from the specified input to the internal 100 Ω resistor if the resistor assignment for the input is being set to none.

8.7.3.62 INP:RS:ADD <id>

Example command: INP:RS:ADD "R25_01322"

Password protection: Resistor Protection

Adds a new resistor definition to the Resistor Library. Before a resistor can be assigned to an input (see commands INP:RS:FRON:IDEN and INP:RS:REAR:IDEN) and used as a reference resistor, the resistor must have its definition added to the Resistor Library.

Parameter <id> is the ID of the new resistor definition. It can contain letters, numerals, hyphens, periods, forward slashes, and underscores. It must be between one and 22 characters in length, inclusive.

If <id> is different from all other IDs in the Resistor Library and space is available in the Resistor Library, a new resistor definition will be added and given the specified ID. The resistor parameters will initially be set to default values. The command INP:RS:PAR should be used to set the parameters.

If <id> matches the ID of a resistor already in the Resistor Library or the Resistor Library is full, no new resistor definition is added, and error -224, "Illegal parameter value" will be generated in the error queue.

8.7.3.63 INP:RS:COUN?

Reads the number of resistor definitions in the Resistor Library.

8.7.3.64 INP:RS:DEL <id>

Example command: CALC:PROB:DEL "R25_01322"

Password protection: Resistor Protection

Deletes a resistor definition from the Resistor Library.

Parameter <id> is the ID of the resistor definition to delete. If <id> does not match the ID of any resistor in the Resistor Library, nothing is deleted, and error -224, "Illegal parameter value" is generated in the error queue.

If the deleted resistor was assigned to an input (see commands INP:RS:FRON:IDEN and INP:RS:REAR:IDEN), the input's reference resistor (Rs) setting will be changed to variable. The Calculation setting for any channel that used the input for its Reference Resistor (Rs) setting will be changed from temperature or resistance to ratio.

8.7.3.65 INP:RS:FIRS?

Example response: "R25_01322"

Reads the ID of the first resistor in the Resistor Library. It also resets the catalog index used by the INP:RS:NEXT? command.

If the Probe Library is empty, no response is given and error -230, "Data corrupt or stale" is generated in the error queue.

8.7.3.66 INP<n>:RS:IDEN <id>|VAR|NONE

Example command: INP2:RS:IDEN "R25_01322"

Example command: INP4:RS:IDEN NONE

Query form: INP<n>:RS:IDEN?

Example query response: "R25_01322"

Example query response: VAR

Sets the resistor definition assigned to a front reference resistor input. (Use the command INP:REAR<n>:RS:IDEN to assign a resistor definition to a rear Rs input.)

Suffix <n> specifies the front input (channel) number and must be either 2 or 4.

Parameter <id> must be either the ID of a resistor definition in the Resistor Library, “VAR” (variable), or “NONE”. Enclosing quotations marks are optional. If <id> does not match the ID of a resistor definition in the Resistor Library or an allowed option, error -224, “Illegal parameter value” is generated in the error queue.

The response to the query form is the ID of the resistor enclosed in quotation marks if a valid resistor ID is assigned to the input. If the resistor assignment is variable or none, the response is “VAR” or “NONE” respectively, without quotation marks.

A channel’s Calculation setting will be changed from temperature to resistance (see Section 8.7.3.27, CALC<n>:TYPE TEMP|RES|RAT, on page 80) if its Reference Resistor (Rs) setting was set to the specified input and the resistor assignment for the input is set to variable. A channel’s Reference Resistor (Rs) setting will be changed from the specified input to the internal 100 Ω resistor if the resistor assignment for the input is being set to none.

8.7.3.67 INP:RS:NEXT?

Example response: “R100_023”

Reads the ID of the next resistor in the Resistor Library. It also advances the library index used for the next response to the INP:RS:NEXT? command.

If there are no more resistors in the Resistor Library, no response is given and error -230, “Data corrupt or stale” is generated in the error queue.

8.7.3.68 INP:RS:OVEN:STAB?

Returns the stable condition of the oven. The response is 1 if the temperature is stable and 0 if not.

8.7.3.69 INP:RS:PAR <id>,<name>,<value>

Example command: INP:RS:PAR “R25_01322”,RES,25.001098

Query form: INP:RS:PAR? <id>,<name>

Password protection: Resistor Protection

Sets the value of a setting in a resistor definition.

Parameter <id> is the ID of a resistor definition in the Resistor Library. If <id> does not match the ID of a resistor definition in the Resistor Library, error -224, “Illegal parameter value” is generated in the error queue.

Parameter <name> specifies the setting to set. Settings and their associated names are listed in the table below (also see Section 5.7.1.2.1.1.1, DEFINE RESISTOR (F2), on page 31).

Setting	<name>	<value> type or options
Resistance	RES	decimal number
Maximum Current	MAX_CURR	decimal number
Calibration Date	CAL_DATE	string: “<yyyy>-<mm>-<dd>”
Due Date	DUE_DATE	string: “<yyyy>-<mm>-<dd>”

8.7.3.70 INP<n>:RS:ROUT <source>

Query form: INP<n>:RS:ROUT?

Sets a channel’s Reference Resistor (Rs) setting (see Section 5.7.1.2, CHANNEL SETTINGS (F2), on page 30).

Suffix <n> specifies the channel number: 1 through 4 for the corresponding front channel input, 5 through 14 for channels of the first attached scanner, and 15 through 24 for channels of the second attached scanner.

Parameter <source> may be any of the following:

<source>	Function
1	Selects the internal 1 Ω resistor for the reference resistor
10	Selects the internal 10 Ω resistor for the reference resistor
25	Selects the internal 25 Ω resistor for the reference resistor
100	Selects the internal 100 Ω resistor for the reference resistor
10K	Selects the internal 10 kΩ resistor for the reference resistor
RS1	Selects the rear RS1 input as the source for the reference resistor
RS2	Selects the rear RS2 input as the source for the reference resistor
CH2	Selects the front Channel 2 input as the source for the reference resistor
CH4	Selects the front Channel 4 input as the source for the reference resistor

An input option is not allowed if the resistor assignment for the input is NONE (see Section 8.7.3.61, INP:REAR<n>:RS:IDEN <id>|VAR|NONE, on page 87 and Section 8.7.3.66, INP<n>:RS:IDEN <id>|VAR|NONE, on page 88), in which case an error -221, “Settings conflict” is generated in the error queue. Also, Channel 2 cannot be set to CH2 and Channel 4 cannot be set to CH4.

8.7.3.71 ROUT:CLOS <channel>

Query form: ROUT:CLOS?

Example command: ROUTE:CLOSE (@3)

Example response: (@3)

Selects one channel for measurement.

The lowest channel appearing in <channel list> is enabled, and all other channels are disabled. The Scan Enable setting is set to OFF (see Section 5.7.3.1, SCAN SETTINGS (F1), on page 39). If measurement is disabled, the channel will not actually be measured until measurement is started. If measurement of another channel is in progress, the new channel will not be measured until the measurement completes.

A channel number in <channel list> may be 1 through 4 for the corresponding front channel input, 5 through 14 for channels of the first attached scanner, and 15 through 24 for channels of the second attached scanner. If a scanner is attached, channel 1 is not allowed.

The channel is specified in channel list format, preceded by an @ character, everything enclosed in parenthesis.

If scanning is on, the query will return an empty channel list.

8.7.3.72 ROUT:CLOS:STAT?

Example response: (@2)

Returns the channel number of whatever channel is actively being measured, whether or not scanning is enabled. If measurement is off, an empty channel list is returned.

8.7.3.73 ROUT:SCAN <channel list>

Example command: ROUTE:SCAN (@1,2,4,6:14)

Query form: ROUT:SCAN?

Example query response: (@1,2,3,4)

Enables channels for scanning.

Each of the channels specified in <channel list> is enabled (this is equivalent to setting each channel ON in the Channel Menu), and all other channels are disabled. The Scan Enable setting is set to ON (see Section 5.7.3.1, SCAN SETTINGS (F1), on page 39). If measurement is disabled, the channels will not actually be scanned and measured until measurement is started.

A channel number in <channel list> may be 1 through 4 for the corresponding front channel input, 5 through 14 for channels of the first attached scanner, and 15 through 24 for channels of the second attached scanner. If a scanner is attached, channel 1 will not be enabled.

A range of channels may be conveniently included in the channel list by using a colon between the channel range limits. The query response lists all enabled channels separately. If scanning is off, the query will return an empty channel list.

The *RST command enables channel 2 and disables all others.

8.7.3.74 ROUT:SCAN:ADD <channel list>

Example command: ROUTE:SCAN:ADD (@5,6,7)

Adds channels to the scan list.

Each of the channels specified in <channel list> is enabled (this is equivalent to setting each channel ON in the Channel Menu). The Scan Enable setting is set to ON (see Section 5.7.3.1, SCAN SETTINGS (F1), on page 39). If measurement is disabled, the channels will not actually be scanned and measured until measurement is started.

A channel number in <channel list> may be 1 through 4 for the corresponding front channel input, 5 through 14 for channels of the first attached scanner, and 15 through 24 for channels of the second attached scanner. If a scanner is attached, channel 1 will not be enabled.

8.7.3.75 ROUT:SCAN:ALT <boolean>

Query form: ROUT:SCAN:ALT?

Alternate parameter: DEF

Sets the scan Alternate Reference setting (see Section 5.7.3.1, SCAN SETTINGS (F1), on page 39).

The *RST command sets Alternate Reference to its default setting which is OFF.

8.7.3.76 ROUT:SCAN:DEL <channel list>

Example command: ROUTE:SCAN:DEL (@4)

Removes channels from the scan list.

Each of the channels specified in <channel list> is disabled (this is equivalent to setting each channel OFF in the Channel Menu).

8.7.3.77 ROUT:SCAN:REF <channel>

Query form: ROUT:SCAN:REF?

Example command: ROUTE:SCAN:REF 4

Sets the scan Reference Channel setting (see Section 5.7.3.1, SCAN SETTINGS (F1), on page 39).

Parameter <channel> is the front channel number to use as the reference, which may be 1 through 4 when no scanner is attached. If a scanner is attached, the channel 1 option is not available but the scanner channels are allowed, numbered 5 through 14 for the first scanner, 15 through 24 for the second. The default option is channel 2. For the reference channel to be measured, it must be enabled (see command Channel Menu).

The *RST command sets Reference Channel to 2.

8.7.3.78 ROUT:SCAN:REP <value>

Example command: ROUT:SCAN:REP 10

Query form: ROUT:SCAN:REP?

Alternate parameter: DEF, MIN, MAX

Sets the scan Repeat Count setting (see Section 5.7.3.1, SCAN SETTINGS (F1), on page 39).

Parameter <value> is the number of measurements performed on a channel before advancing to the next channel. The range is 1 through 100 and the default is 1.

The *RST command sets Repeat Count to 1.

8.7.3.79 ROUT:SCAN:STAT <boolean>

Query form: ROUT:SCAN:STAT?

Alternate parameter: DEF

Sets the Scan Enable setting (see Section 5.7.3.1, SCAN SETTINGS (F1), on page 39).

The *RST command sets Scan Enable to the default setting which is ON.

8.7.3.80 SENS:APER[:DISP] <time>

Query form: SENS:APER[:DISP]?

Alternate parameter: DEF, MIN, MAX

Password protection: Measure Protection

Sets the measurement or Display Interval (see Section 5.7.3.2, TIMING SETTINGS (F2), on page 39).

Parameter <time> is in seconds. Allowed values for <time> are 1, 2, 10, 30, and 60. Values other than these are rounded down to the nearest allowed value.

The Sample Period setting will be changed if necessary so that it is never greater than the Display Interval setting.

The *RST command sets Display Interval to the default setting which is 2.

8.7.3.81 SENS:APER:PRES NORM|PREC|FAST|LONG

Query form: SENS:APER:PRES?

Alternate parameter: DEF

Sets the measurement timing settings to preset values (see Section 5.7.3.2, TIMING SETTINGS (F2), on page 39). This is equivalent to pressing the PRESET NORMAL, PRESET PRECISION, PRESET FAST, or PRESET LONG function key in the Timing Settings screen. It affects the Sample Period, Display Interval, and Average Enable settings.

For the query form, if the timing settings match one of the presets, the name of the preset is returned. If the settings do not match any of the presets, "NONE" is returned.

The *RST command sets the timing settings to the default preset which is NORM.

8.7.3.82 SENS:APER:SAMP <time>

Query form: SENS:APER:SAMP?

Alternate parameter: DEF, MIN, MAX

Password protection: Measure Protection

Sets the measurement Sample Period (see Section 5.7.3.2, TIMING SETTINGS (F2), on page 39).

Parameter <time> is in seconds. Allowed values for <time> are 1, 2, 5, and 10. Values other than these are rounded down to the nearest allowed value.

The Display Interval setting will be changed if necessary so that it is never less than the Sample Period setting.

The *RST command sets Sample Period to the default setting which is 2 seconds.

8.7.3.83 SENS:AVER1[:STAT] <boolean>

Query form: SENS:AVER1?

Password protection: Measure Protection

Sets the Average Enable for the sample average (see Section 5.7.3.2, TIMING SETTINGS (F2), on page 39).

The *RST command sets Average Enable to the default setting which is ON.

8.7.3.84 SENS:AVER2[:STAT] <boolean>

Query form: SENS:AVER2?

Password protection: Measure Protection

Sets the digital filter's Filter Enable (see Section 5.7.3.3, DIGITAL FILTER (F3), on page 41).

The *RST command sets Filter Enable to the default setting which is ON.

8.7.3.85 SENS:AVER2:COUN <count>

Query form: SENS:AVER2:COUN?

Alternate parameter: DEF, MIN, MAX

Password protection: Measure Protection

Sets the digital filter's Average Count setting (see Section 5.7.3.3, DIGITAL FILTER (F3), on page 41).

Parameter <count> is the average count. Allowed values range from 2 through 100.

This setting is only meaningful when Filter Enable is ON.

The *RST command sets Average Count to the default setting, which is 30.

8.7.3.86 SENS:AVER2:CLEA

Clears the digital filter buffer. This is equivalent to pressing the CLEAR FILTER function key in the Digital Filter screen (see Section 5.7.3.3, DIGITAL FILTER (F3), on page 41).

8.7.3.87 SENS[<n>][:FRES]:DATA?

Example command: SENS4:DATA?

Example response: 44.221571

Reads a channel's latest resistance measurement.

Suffix <n> is the channel number: 1 through 4 for the corresponding front channel input, 5 through 14 for channels of the first attached scanner, and 15 through 24 for channels of the second attached scanner. If the suffix number is omitted, the latest measurement regardless of channel is returned.

If the Calculation setting for the channel is either RESISTANCE or TEMPERATURE (see Section 8.7.3.27, CALC<n>:TYPE TEMP|RES|RAT, on page 80), a resistance value in ohms is returned. If calculation is ratio, a resistance ratio value is returned. In either case, the returned value is obtained after processing by the digital filter.

If no measurement is available, no response is returned and error code -230, "Data corrupt or stale" is generated in the error queue.

8.7.3.88 SENS[<n>]:RRAT:DATA?

Example command: SENS4:RRAT:DATA?

Example response: 1.30244715

Reads a channel's latest resistance ratio measurement.

Suffix <n> is required, which specifies the channel number: 1 through 4 for the corresponding front channel input, 5 through 14 for channels of the first attached scanner, and 15 through 24 for channels of the second attached scanner. If the suffix number is omitted, the latest measurement regardless of channel is returned.

The returned value is a resistance ratio after processing by the digital filter. If no measurement is available, no response is returned and error code -230, "Data corrupt or stale" is generated in the error queue.

8.7.3.89 STAT:OPER?

Example response: 16

Reads and clears the Operation Status Event Register. This indicates whether a new measurement became available to read (using FETC?) since the previous STAT:OPER? query. The return value is 16 if a new measurement has been acquired and 0 otherwise. Reading the Operation Status Event Register using this command clears the register. The register is also cleared when a *CLS or FETC? command is received.

8.7.3.90 STAT:OPER:COND?

Example response: 16

Reads the Operation Status Condition Register. This indicates whether or not measurement is enabled. The return value is 16 if measurement is enabled and 0 otherwise. Reading the Operation Status Condition Register does not change it.

8.7.3.91 STAT:OPER:ENAB <value>

Example command: STAT:OPER:ENAB 16

Query form: STAT:OPER:ENAB?

Alternate parameter: DEF

Sets the Operation Status Enable Register. This mask register determines which corresponding bits of the Operation Status Event Register affect the Operation Status Bit (OSB, bit 7) of the Status Byte Register. A value of 16 enables reporting when a new measurement is acquired. The default setting is 0.

8.7.3.92 STAT:QUES?

Example response: 16

Reads and clears the Questionable Status Event Register. This indicates whether a new measurement that was erroneous or questionable was acquired since the previous STAT:QUES? query.

The bits in the Questionable Status Event Register correspond to the bits in the Questionable Status Condition Register and are caused by the same conditions (see Section 8.7.3.93, STAT:QUES:COND?, on page 94). The difference is the bits in the Questionable Status Event Register remain set after the condition no longer exists. Reading the Questionable Status Event Register using the STAT:QUES? command clears the register. The register is also cleared when a *CLS command is received.

8.7.3.93 STAT:QUES:COND?

Example response: 16

Reads the Questionable Status Condition Register. This indicates whether the latest measurement was erroneous or questionable.

The return value is 16 if the latest measurement is questionable and 0 otherwise. The Questionable Status Condition Register is cleared when a new valid measurement is acquired. Reading the Questionable Status Condition Register does not change it.

8.7.3.94 STAT:QUES:ENAB <value>

Example command: STAT:QUES:ENAB 16

Query form: STAT:QUES:ENAB?

Alternate parameter: DEF

Sets the Questionable Status Enable Register. This mask register determines which corresponding bits of the Questionable Status Event Register affect the Questionable Status Bit (QSB, bit 3) of the Status Byte Register. A value of 16 enables reporting of questionable measurements. The default setting is 0.

8.7.3.95 SYST:BEEP[:IMM]

Example command: SYST:BEEP

Produces an immediate beep from the speaker.

8.7.3.96 SYST:BEEP:KEY <boolean>

Query form: SYST:KEY:BEEP?

Alternate parameter: DEF

Sets the Key Beep setting (see Section 5.7.4.1, USER SETTINGS (F1), on page 47). The default setting is ON.

8.7.3.97 SYST:BEEP:ALER <boolean>

Query form: SYST:KEY:ALER?

Alternate parameter: DEF

Sets the Alert Beep setting (see Section 5.7.4.1, USER SETTINGS (F1), on page 47). The default setting is ON.

8.7.3.98 SYST:CODE:VERS?

Example response: 1.23,1.00,1.10

Reads the firmware code version numbers. The response contains the following:

<UI version>,<kernel version>,<analog version>

8.7.3.99 SYST:COMM:GPIB:ADDR <value>

Query form: SYST:COMM:GPIB:ADDR?

Alternate parameter: DEF, MIN, MAX

Sets the IEEE-488 port's Address setting (see Section 8.6, Configuring the IEEE-488 Port, on page 69).

8.7.3.100 SYST:COMM:GPIB[:STAT] <boolean>

Query form: SYST:COMM:GPIB?

Sets the IEEE-488 port's Port Enable setting (see Section 8.6, Configuring the IEEE-488 Port, on page 69).

8.7.3.101 SYST:COMM:GPIB:TERM LIN|RET

Query form: SYST:COMM:GPIB:TERM?

Sets the IEEE-488 port's Termination setting (see Section 8.6, Configuring the IEEE-488 Port, on page 69).

8.7.3.102 SYST:COMM:SER:BAUD <value>

Query form: SYST:COMM:SER:BAUD?

Sets the serial port Baud Rate setting (see Section 8.5, Configuring the RS-232 Serial Port, on page 69).

8.7.3.103 SYST:COMM:SER:LIN <boolean>

Query form: SYST:COMM:SER:LIN?

Alternate parameter: DEF

Sets the serial port's Linefeed setting (see Section 8.5, Configuring the RS-232 Serial Port, on page 69).

8.7.3.104 SYST:COMM:SOCK:ADDR <IP address>

Example command: SYST:COMM:SOCK:ADDR "147.120.0.11"

Query form: SYST:COMM:SOCK:ADDR?

Sets the network port's IP Address setting (see Section 8.2, Configuring the Network (LAN) Port, on page 65).

Parameter <IP address> is a string specifying the address using IP dot notation.

This setting is only allowed when DHCP is OFF.

The query form returns the static IP address when DHCP is OFF and returns the dynamically assigned IP address when DHCP is ON.

8.7.3.105 SYST:COMM:SOCK:CONT OFF|ON|QUER

Query form: SYST:COMM:SOCK:CONT?

Sets the network port's Control Enable setting. This determines whether the instrument accepts control commands received via the network port.

Allowed parameter values are OFF, ON, and QUER. When the setting is OFF the network port cannot be used to control the instrument, and all commands are ignored. When the setting is ON commands may be used to control and operate the instrument. When the setting is QUER, commands that read settings and data are allowed, but commands that change settings are ignored. The default setting is QUER.

8.7.3.106 SYST:COMM:SOCK:DHCP <boolean>

Query form: SYST:COMM:SOCK:DHCP?

Sets the network port's DHCP Enable setting (see Section 8.2, Configuring the Network (LAN) Port, on page 65).

8.7.3.107 SYST:COMM:SOCK:GAT <IP address>

Example command: SYST:COMM:SOCK:GAT "147.120.0.1"

Query form: SYST:COMM:SOCK:GAT?

Sets the network port's Gateway setting (see Section 8.2, Configuring the Network (LAN) Port, on page 65).

Parameter <IP address> is a string specifying the address of the gateway server, using IP dot notation.

This setting is only meaningful when DHCP is OFF.

The query form returns the value of the Gateway setting when DHCP is OFF and returns the dynamically provided gateway address when DHCP is ON.

8.7.3.108 SYST:COMM:SOCK:KEEP <seconds>

Example command: SYST:COMM:SOCK:KEEP 3600

Query form: SYST:COMM:SOCK:KEEP?

Alternate parameter: DEF, MIN, MAX

Sets the network port's keep-alive timeout setting.

Parameter <seconds> is the keep-alive timeout value, in seconds.

This setting determines the length of time, in seconds, after which the socket is automatically closed if there is no activity. At power-on the setting defaults to 60 seconds. If a different timeout is desired, the settings can be changed using this command. If the setting is set to 0, the keep-alive timeout will be disabled.

The keep-alive timeout may be useful if a connection is dropped unexpectedly, such as if the network or client fails. The network socket of the Super-Thermometer might otherwise remain open indefinitely, and no subsequent socket connection request would be accepted. With the keep-alive timeout enabled, if no activity is detected during the timeout period, the socket will close automatically, and a new connection will then be accepted.

In applications where there might normally be a long period between messages, it might be necessary to increase or disable the keep-alive timeout to prevent the connection from being closed automatically.

8.7.3.109 SYST:COMM:SOCK:MAC?

Example response: "00204A9AF1A2"

Reads the network port's Hardware MAC address (see Section 8.2, Configuring the Network (LAN) Port, on page 65).

8.7.3.110 SYST:COMM:SOCK:MASK <IP address>

Example command: SYST:COMM:SOCK:MASK "255.255.255.0"

Query form: SYST:COMM:SOCK:MASK?

Sets the network port's Subnet Mask setting (see Section 8.2, Configuring the Network (LAN) Port, on page 65).

Parameter <IP address> is a string specifying the subnet mask, using IP dot notation.

This setting is only meaningful when DHCP is OFF.

The query form returns the value of the Subnet Mask setting when DHCP is OFF and returns the dynamically provided subnet mask when DHCP is ON.

8.7.3.111 SYST:COMM:SOCK:NAME <name>

Example command: SYST:COMM:SOCK:NAME "MY-1595A"

Query form: SYST:COMM:SOCK:NAME?

Alternate parameter: DEF

Sets the network port's Host Name setting (see Section 8.2, Configuring the Network (LAN) Port, on page 65).

Parameter <name> is a string specifying the Host Name. The string may contain upper-case letters, numerals, and underscores and may be up to 24 characters in length. Issuing the command with parameter "DEF" sets the Host Name to the default value, which is "FLUKE-159X-<serial number>".

8.7.3.112 SYST:COMM:USB[:STAT] <boolean>

Query form: SYST:COMM:USB?

Sets the USB port's Port Enable setting (see Section 8.4, Configuring the USB Port, on page 68).

8.7.3.113 SYST:CONF:CHAN?

Example response: 4

Reads the number of available channels. The Super-Thermometer by itself has 4 available channels. If one optional scanner is attached, the number of available channels will be 14. If two optional scanners are attached, the number of available channels will be 24. (Channel 1 is counted even though it is not enabled when a scanner is attached.)

8.7.3.114 SYST:CONF:SCAN?

Example response: "2590"

Reads the model number of an attached scanner. The model number is enclosed in quotation characters. If no scanner is attached, the response is an empty string enclosed in quotation characters.

8.7.3.115 SYST:DATE <year>,<month>,<day>

Query form: SYST:DATE?

Example query response: 2009,12,31

Password protection: Time/Date Protection

Sets the Date of the system clock.

8.7.3.116 SYST:ERR?

Example response: -100,“Command error”

Reads the next error in the error queue. When an error is read it is removed from the error queue, and the next error may be read by sending the command again. If there are no more errors, the response is 0,“No error”. The error queue holds ten errors. If the error queue is already full when a new error is generated, the last error in the error queue is replaced with the error, -350,“Queue overflow”. The error queue may be cleared using the command *CLS. Possible errors are listed in the following table.

Error	Cause
0;“No error”	The error queue is empty.
-100;“Command error”	An unrecognized command was received.
-109;“Missing parameter”	A required parameter was missing.
-114;“Header suffix out of range”	A suffix number was out of range. (This may occur if a channel does not exist because the scanner is not attached.)
-130;“Suffix error”	A required suffix number is missing.
-200;“Execution error”	A command could not be executed.
-203;“Command protected”	A command could not be executed because a setting is password protected.
-220;“Parameter error”	A command could not be executed because one or more parameters are out of range or invalid.
-221;“Settings conflict”	A command could not be executed in the current state of the instrument.
-222;“Data out of range”	A command could not be executed because a parameter was out of range, of the wrong type, or not recognized.
-224;“Illegal parameter value”	A command could not be executed because a parameter was not an allowed option.
-230;“Data corrupt or stale”	A response could not be returned because valid data is not available.
-330;“Self-test failed”	A self-test failed because of a hardware error.
-350;“Queue overflow”	An error occurred when the error queue was full.
-360;“Communication error”	A communication error occurred, such as a framing error or input buffer overrun.
-400;“Query error”	A response to a query was not transmitted prior to another command being received.

8.7.3.117 SYST:KLOC <boolean>

Query form: SYST:KLOC?

Alternate parameter: DEF

Sets the front-panel key lock.

If the parameter is 1, front-panel keys are inoperable. The key lock remains on until the command is sent with the parameter 0.

The key lock setting is initially off at power-on. The *RST command sets key lock off.

8.7.3.118 SYST:PASS:CDIS

Disables access to password-protected settings. The SYST:PASS:CEN command may be used subsequently to enable access.

8.7.3.119 SYST:PASS:CEN <password>

Example command: SYST:PASS:CEN 1234

Enables access to password-protected settings. If <password> is incorrect, error -221,“Settings conflict” is generated in the error queue. Password access remains enabled until the SYST:PASS:CDIS command is received. Password access is disabled at power-on.

- 8.73.120 SYST:PASS:CEN:STAT?**
Returns the password-access state. The response is 0 if access is disabled and 1 if access is enabled.
- 8.73.121 SYST:PASS:GROU:MEAS <boolean>**
Query form: SYST:PASS:GROU:MEAS?
Password protection: unconditional
Alternate parameter: DEF
Sets the password Measure Protection setting (see Section 5.7.7.1, PASSWORD (F4), on page 54). When Measure Protection is on, settings related to measurement, and their associated commands, are protected.
- 8.73.122 SYST:PASS:GROU:PROB <boolean>**
Query form: SYST:PASS:GROU:PROB?
Password protection: unconditional
Alternate parameter: DEF
Sets the password Probe Protection setting (see Section 5.7.7.1, PASSWORD (F4), on page 54). When Probe Protection is on, settings related to probe definition, and their associated commands, are protected.
- 8.73.123 SYST:PASS:GROU:RES <boolean>**
Query form: SYST:PASS:GROU:RES?
Password protection: unconditional
Alternate parameter: DEF
Sets the password Resistor Protection setting (see Section 5.7.7.1, PASSWORD (F4), on page 54). When Resistor Protection is on, settings related to resistor definition, and their associated commands, are protected.
- 8.73.124 SYST:PASS:GROU:TIME <boolean>**
Query form: SYST:PASS:GROU:TIME?
Password protection: unconditional
Alternate parameter: DEF
Sets the password Time/Date Protection setting (see Section 5.7.7.1, PASSWORD (F4), on page 54). When Time/Date Protection is on, setting the time and date is protected.
- 8.73.125 SYST:PASS:NEW <current password>,<new password>**
Example command: SYST:PASS:NEW 1234,9999
Changes the password. If <current password> is incorrect, error -221, "Settings conflict" is generated in the error queue.
- 8.73.126 SYST:PON:MIN?**
Returns the time in minutes since power on.
- 8.73.127 SYST:TIME <hour>,<minute>,<second>**
Query form: SYST:TIME?
Example query response: 23,59,59
Password protection: Time/Date Protection
Sets the Time of the system clock.
- 8.73.128 SYST:TIME:DAYL OFF|NAM|EUR**
Example command: SYST:TIME:DAYL NAM

Query form: SYST:TIME:DAYL?

Password protection: Time/Date Protection

Alternate parameter: DEF

Sets the Daylight Saving automatic adjust setting (see Section 5.7.5.1, TIME DATE (F1), on page 50).

Allowed parameter values are OFF for no automatic daylight saving adjustment, NAM for adjustment according to the schedule used in North America (the United States, Canada, and Mexico), and EUR for adjustment according to the schedule used in Europe. The default setting is OFF.

8.7.3.129 TEST:CURR:CONF <channel>,<current>,<polarity>

Query form: TEST:CURR:CONF?

Example query response: 2,1.0,0

Sets the configuration of the sensing current test (see Section 9, Calibration, on page 103).

Parameter <channel> may be 1 through 4, referring to front channels 1 through 4.

Parameter <current> is the driving current.

Parameter <polarity> sets the direction of the current and may be either 0 for forward or 1 for reverse.

8.7.3.130 TEST:CURR[:STAT] <boolean>

Query form: TEST:CURR?

Sets the state of the sensing current test (see Section 9, Calibration, on page 103).

Parameter <boolean> given a value of 1 starts the sensing current test if it is off. A value of 0 stops the sensing current test if it is on.

During the sensing current test a constant current is sourced at the current terminals of a channel. The channel, current magnitude, and polarity may be specified using the TEST:CURR:CONF command. While a sensing current test is in progress, the display shows the Current Test status screen. Also, the 0 bit of the Operation Status Condition Register is set while the test is in progress, and is cleared when the test is stopped.

A sensing current test is stopped if the *RST command is received.

8.7.3.131 TEST:LIN:ABOR

Cancels Ratio Self-Calibration (see Section 9, Calibration, on page 103).

Ratio Self-Calibration is also canceled if the *RST command is received.

8.7.3.132 TEST:LIN:PAR?

Example response: 0.12,0.05,-0.03,-0.02

Reads the suggested calibration Linearity C<n> parameters (see Section 9, Calibration, on page 103) resulting from the Ratio Self-Calibration.

The response contains the following:

<C1>,<C2>,<C3>,<Zero>

A response is returned only if the Ratio Self-Calibration runs to completion. If no linearity self-test report is available, error -230, "Data corrupt or stale" is generated in the error queue.

8.7.3.133 TEST:LIN:INIT

Query form: TEST:LIN:INIT?

Starts Ratio Self-Calibration (see Section 9, Calibration, on page 103).

If Ratio Self-Calibration is already in progress, error -213, "Init ignored" is generated in the error queue. While Ratio Self-Calibration is in progress, the display shows the Ratio Calibration status screen.

The query form returns 1 if Ratio Self-Calibration is in progress, 0 otherwise.

8.7.3.134 TEST:LIN:REP<n>?

Example response: 0.00000002,0.00000001,0.00000002,0.02,0.003

Reads a report from Ratio Self-Calibration (see Section 9, Calibration, on page 103).

Suffix <n> specifies the test number of which a report is requested:

<n>	Linearity self-test type
1	zero check
2	compliment check
3	equal ratio sum, 100% scale
4	equal ratio sum, 90% scale
5	equal ratio sum, 75% scale
6	equal ratio sum, 60% scale
7	equal ratio sum, 50% scale
8	unequal ratio sum

The normal response contains the following:

<result A>,<result B>,<combined>,<error>,<std error>

<result A> is the mean measurement from the first part of the test.

<result B> is the mean measurement from the second part of the test.

<combined> is the combined result of the two parts.

<error> is the difference between <combined> and the expected value, in units of 1×10^{-6} .

<std error> is the standard error of <error>, in units of 1×10^{-6} . The standard errors of <result A> and <result B> are calculated by dividing their standard deviations by the square root of the sample size, and then the two values are combined using a root-sum-square calculation.

A report is available only if the Ratio Self-Calibration runs to completion. If no report is available, error -230, "Data corrupt or stale" is generated in the error queue. If the power is switched off and then on again, the values <result A>, <result B>, and <combined> will no longer be available and will be missing in the command response.

8.7.3.135 TEST:LIN:REP:TIME?

Example response: 2009-06-24 14:30:48

Reads the date and time of the most recent Ratio Self-Calibration report (see Section 9, Calibration, on page 103). The date is in the format YYYY-MM-DD. The time is in 24-hour format. If Ratio Self-Calibration has not yet completed, error -230, "Data corrupt or stale" is generated in the error queue.

8.7.3.136 TEST:LIN[:STAT]?

Example response: 5

Reads the state of the Ratio Self-Calibration (see Section 9, Calibration, on page 103).

A non-zero response indicates calibration is in progress, and the value designates which test number is in progress. The response is 0 calibration is not running.

8.7.3.137 TEST:LIN:TIME?

Example response: 205

Reads the time remaining of the Ratio Self-Calibration. The time remaining is a number of seconds.

8.7.3.138 TEST:LIN:TOL<n>?

Example response: 0.8

Reads a Ratio Self-Calibration test tolerance (see Section 9, Calibration, on page 103).

Suffix <n> specifies the test number of which the error tolerance is requested (see Section 8.7.3.134, TEST:LIN:REP<n>?, on page 101).

The response has units of 1×10^{-6} .

8.7.3.139 TEST:SYST:ABOR

Cancels a system self-test (see Section 9, Calibration, on page 103).

A system self-test is also canceled if the *RST command is received.

8.7.3.140 TEST:SYST:INIT

Starts a system self-test (see Section 9.2, SYSTEM TEST (F1), on page 103).

If a system self-test is already in progress, error -213, "Init ignored" is generated in the error queue. While a system self-test is in progress, the display shows the System Test status screen. Also, the 0 bit of the Operation Status Condition Register is set while the test is in progress, and is cleared when the test ends or is aborted.

8.7.3.141 TEST:SYST:REP[<n>]?

Example response: 0

Reads the report from a system self-test.

Parameter <n>, when given a value of 1 or omitted, specifies the report from the power-on system self-test. A value of 2 specifies the report from the latest system self-test if one was performed subsequent to the power-on system self-test and a system self-test is not in progress. A report only becomes available if the system self-test runs to completion. If no report is available, error -230, "Data corrupt or stale" is generated in the error queue.

The response is 0 if no errors occurred.

8.7.3.142 TEST:SYST:STAT?

Example response: 1

Reads the state of the system self-test (see Section 9.2, SYSTEM TEST (F1), on page 103).

A response of 1 indicates a test is in progress, 0 otherwise.

8.7.3.143 UNIT:TEMP C|K|F

Example command: UNIT:TEMP C

Query form: UNIT:TEMP?

Alternate parameter: DEF

Sets the temperature Unit (see section Unit). The option F (Fahrenheit) will not be available if The SI Unit Lock setting is ON (see Section 9.6, CALIBRATION PARAMETERS (F5), on page 108).

The *RST command sets Unit to the default setting which is C.

9 Calibration

9.1 Introduction

This section explains the step-by-step instructions for calibrating and verifying functionality of the Super-Thermometer to ensure it will operate correctly and meet published specifications. If the instrument cannot be brought into specification using these instructions, contact the nearest Fluke Authorized Service Center.

A complete Super-Thermometer calibration is comprised of four parts; Self Test, Ratio Self-Calibration, Internal Resistor Calibration, and Current Test. The user may perform all four parts or only a single part if desired. Built-in functions automate all of the test and calibration steps except Current Test. The functions are found in the Calibration menu. Go to the Calibration menu by pressing the MENU key then the SYSTEM MENU (F5) function key followed by the CALIBRATION (F5) function key.

The unit should be allowed to warm up for at least 30 minutes before performing any calibration. Self Test can be performed at any time during or after the warm up period.

IMPORTANT: Make sure the OVEN indicator on the Measurement Screen shows READY before performing any calibration.

9.2 SYSTEM TEST (F1)

System Test performs several internal functionality tests and reports the results. It is not necessary to allow the Super-Thermometer to pass through the required warm-up period before performing this test.

To run System Test, press the SYSTEM TEST (F1) function key. Press the START (F1) function key to begin the system self-test. As the test proceeds, the screen indicates the time remaining. The user may press the CANCEL (F5) function key or EXIT key to cancel the test. When the test is finished, the results are displayed. If a failure is indicated, contact the nearest Fluke Authorized Service Center.

9.3 CURRENT TEST (F2)

The Current Test allows the user to test the sensing current by applying non-reversing current to the front panel measurement input channels. This is a verification test only, no adjustment is made. It is recommended to measure at least 0.01 mA, 1.0 mA and 1.414 mA on each front panel measurement input channel.

The current can be verified using a current meter or a calibrated 4-wire resistor and digital voltmeter (DVM). If using a current meter, connect the meter in series with the C1 and C2 terminals on one of the input channels as shown in Figure 18.

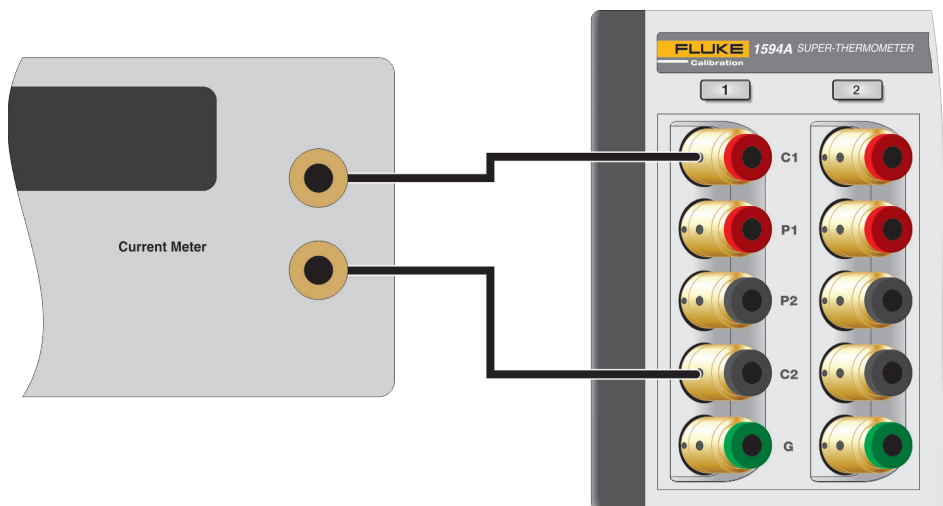

Figure 18 Current meter connection diagram

If using a calibrated resistor, connect the resistor to all four terminals on one of the front panel measurement inputs and connect the voltmeter to the P1 and P2 terminals. Refer to Table 20 for recommended resistance values. The accuracy of the DVM should be better than 0.05 % over the range of 0.02 V to 0.2 V.

Table 20 Recommended Resistors For Testing The Current

Current	Resistor
0.001 mA to 0.02 mA	10 k Ω
0.02 mA to 0.2 mA	1 k Ω
0.2 mA to 2.0 mA	100 Ω
2.0 mA to 20.0 mA	10 Ω

To start the test, press the CURRENT TEST (F2) function key located in the Calibration menu. The following fields are used to configure each step of the test.

CHANNEL - the input channel being tested

CURRENT - the sensing current value

POLARITY - specifies the direction of the sensing current, either forward or reverse

Select the START (F1) function key to begin the current test. Constant current is applied to the specified channel allowing current measurements to be measured by the current meter or voltage readings to be taken across the resistor. During current test, the channel's LED indicator is illuminated green. The channel, current, and polarity may be changed during the test.

Current Test is stopped by pressing the STOP (F1) function key or the EXIT key. This switches off the sensing current allowing the user to connect a different resistor or change any of the configuration fields. Press the EXIT key to leave the test screen.

If using the calibrated resistor and voltmeter method, calculate the actual current by dividing the measured voltage by the value of the resistor. The difference between the actual measured current and the current setting should be within the measurement current accuracy. If the current is not within specification, contact the nearest Fluke Authorized Service Center for more information.

9.4 RATIO CALIBRATION (F3)

The Ratio Self-Calibration function allows the user to perform a ratio linearity check or calibration using an internal resistor network. No other test equipment is required. Due to the simplicity and short time the test takes to run, Ratio Self-Calibration can be performed as often as needed.

Caution: Ratio Self-Calibration does not test resistance accuracy or calibrate the internal reference resistors.

Running the Ratio Self-Calibration function does not require a password. This is because it reports the results of the linearity test only. If adjustment is needed, the Adjust Parameters function is used. This function requires a password because it will adjust internal calibration constants.

The START (F1) function key begins the Ratio Self-Calibration. As the test proceeds, the screen reports the results of each part of the test. The user may press the CANCEL (F5) function key or EXIT key to cancel the test.

The following is a description of each segment of Ratio Self-Calibration:

Test 1 (Zero) - This test evaluates offset errors at a resistance ratio of 0. A 0 Ω resistor is internally connected as Rx, and a 100 Ω resistor is connected as Rs. The test is performed twice, the measurements reported as result A and result B. The combined result is an average of the two. Ideally the measured resistance ratio would be exactly 0.0. The reported error is the difference of the combined result from 0.0, in units of 1×10^{-6} .

Test 2 (Complement) - This test evaluates scale errors at a resistance ratio near 1. The test has two parts. For the first part, a 100 Ω resistor is internally connected as Rx, and another 100 Ω resistor is connected as Rs. The first measured resistance ratio is reported as result A. For the second part, the two resistors are exchanged. The second measured resistance ratio is reported as result B. The combined result is the product of the two mea-

sured resistance ratios. Ideally the product would be exactly 1.0. The reported error is half the difference of the combined result from 1.0, in units of 1×10^{-6} .

Test 3 (Equal ratio sum--100% scale) - This test evaluates linearity errors at a resistance ratio near 0.5 with the measurement circuit operating at full scale. The test has two parts. For the first part, one resistor of a $100 \Omega + 100 \Omega$ resistor network is connected as Rx, and the series combination of the two resistors is connected as Rs internally. The first measured resistance ratio is reported as result A. For the second part, the opposite of the two resistors is connected as Rx and again, the series combination is connected as Rs. The second measured resistance ratio is reported as result B. Ideally the sum of the two measured resistance ratios would be exactly 1.0. The reported error is the difference of the sum from 1.0, in units of 1×10^{-6} .

Test 4 (Equal ratio sum--90% scale) - This test evaluates linearity errors at a resistance ratio near 0.5 with the measurement circuit operating at 90% of full scale. The test is performed in the same way as Test 3, except the measurement circuit gain is reduced so that the circuit operates at the reduced scale. The reported error is the difference of the sum from 1.0, in units of 1×10^{-6} .

Test 5 (Equal ratio sum--75% scale) - This test evaluates linearity errors at a resistance ratio near 0.5 with the measurement circuit operating at 75% of full scale. The test is performed in the same way as Test 3, except the measurement circuit gain is reduced so that the circuit operates at the reduced scale. The reported error is the difference of the sum from 1.0, in units of 1×10^{-6} .

Test 6 (Equal ratio sum--60% scale) - This test evaluates linearity errors at a resistance ratio near 0.5 with the measurement circuit operating at 60% of full scale. The test is performed in the same way as Test 3, except the measurement circuit gain is reduced so that the circuit operates at the reduced scale. The reported error is the difference of the sum from 1.0, in units of 1×10^{-6} .

Test 7 (Equal ratio sum--50% scale) - This test evaluates linearity errors at a resistance ratio near 0.5 with the measurement circuit operating at 50% of full scale. The test is performed in the same way as Test 3, except the measurement circuit gain is reduced so that the circuit operates at the reduced scale. The reported error is the difference of the sum from 1.0, in units of 1×10^{-6} .

Test 8 (Unequal ratio sum) - This test evaluates linearity errors at resistance ratios near 0.25 and 0.75 (with the measurement circuit operating at full scale). The test is performed in the same way as Test 3, except the two resistors are 25Ω and 75Ω . The reported error is the difference of the combined result from 1.0, in units of 1×10^{-6} .

All tests use a sensing current of 1.0 mA. The timing settings are temporarily set to provide measurements at two-second intervals and the digital filter is disabled. The reported measurement of each test is the mean of a set of measurements of the resistance ratio under certain conditions.

For each test a standard error of the mean is calculated and reported. This provides an estimate of the uncertainty of the mean of the reported error due to measurement noise. The standard error of the mean is calculated from the standard deviation (S_A, S_B) of parts A and B and the sample count (n) using the following equation:

$$SE = \frac{1}{a} \sqrt{\frac{S_A^2 + S_B^2}{n}} \times 10^6$$

The sample count is the number of samples comprising the result from each part of the test. The divisor a is 2 for Test 1 and Test 2, accounting for the fact that the reported error is calculated as an average from the two test parts. For the other tests $a = 1$.

When the Ratio Self-Calibration completes, the time and date (when the last test ended) are shown below the test results.

To view the test report screen, the user presses the VIEW REPORT (F1) function key. The report screen shows the specified tolerance, test result error, condition (the percent error relative to the tolerance), and the standard error of the test result error for each individual test. The tolerances shown are based on the 99% confidence level resistance ratio specifications found in the Specifications section.

The Ratio Self-Calibration report data are stored in internal non-volatile memory, overwriting the results of any previous Ratio Calibration. The report of the most recent Ratio Self-Calibration may be viewed at any time using the VIEW PREVIOUS (F2) function key in the Ratio Calibration screen.

The reported data of the Ratio Self-Calibration may be written to a file on a USB memory device using the WRITE FILE (F1) function key in the View Report screen (see Write File below).

The calibration parameters associated with measurement linearity may be adjusted to improve the accuracy if necessary using the ADJUST PARAMETERS (F2) function key (see Adjust Parameters below).

The following function keys are found in the View Report screen.

9.4.1 WRITE FILE (F1)

The Write File function allows the user to write the Ratio Self-Calibration report to a file on the USB memory device.

The user may change the file name by pressing the ENTER key to open the Alpha-Numeric interface and entering a file name. Once the file name is set, and after the USB memory device is inserted into the front USB port, the user presses the CONTINUE (F1) function key to proceed to write the file. The file is stored in a folder named “\159x\test”. If the file already exists, the new test results are added to the file.

The results of each individual test in a Ratio Self-Calibration are written to the file as follows:

```
LINEARITY,<test>,<tolerance>,<error>,<% of tol>,<SE>,<date and time>
```

<test> is the test number, 1 through 8

<tolerance> is the specified tolerance in units of 1×10^{-6}

<error> is the error in units of 1×10^{-6}

<% of tol> is the absolute value of the error divided by the tolerance, expressed in percent

<SE> is the standard error of the test result error in units of 1×10^{-6}

<date and time> is the date and time of the test. The date is in the format YYYY-MM-DD. The time is in 24-hour format.

9.4.2 ADJUST PARAMETERS (F2)

The Adjust Parameters function allows the user to update the linearity parameters (LINEARITY C1, LINEARITY C2, LINEARITY C3, and LINEARITY C4) to correct error observed during the Ratio Self-Calibration.

The Adjust Parameters function is always password protected. The user will be prompted to enter the correct password to continue.

The screen shows the previous values of the calibration parameters and proposed new values based on calculations using the Ratio Calibration test results. The user presses YES (F4) to change the values of the linearity parameters in memory. The user may press the NO (F5) function key or the EXIT key to cancel the change.

When completed, the linearity calibration parameters will be automatically adjusted to correct for the errors observed during the Ratio Self-Calibration. The linearity parameters may be viewed in the Calibration Parameters screen (see Calibration Parameters section). Ratio Self-Calibration should be repeated to verify the calibration.

9.5 RESISTANCE CALIBRATION (F4)

The Resistance Calibration function allows the user to test and calibrate each of the internal reference resistors. It requires a calibrated standard resistor of approximately the same resistance as the internal resistor that will be calibrated.

No password is required to run Resistance Calibration since it first measures an internal resistor without making any adjustment to its internal calibration parameter. After an internal resistor is measured, the results are displayed allowing the user to observe the results and decide if an adjustment is necessary.

Resistance Calibration works by measuring an internal resistor against a calibrated standard resistor. The internal resistor's calibration parameter is adjusted to correct for error.

To properly calibrate a Super-Thermometer internal resistor, the expanded uncertainty ($k = 2$) of the standard resistor should be no greater than 25% of the 95% confidence level, 1-Year Absolute Resistance Accuracy specifications. Its resistance should be approximately the same as that of the internal reference resistor being calibrated, which will result in the least measurement noise and best test uncertainty. The standard resistor may be connected to any one of the four front-panel measurement channels.

To set up the resistance calibration, the user must configure the following fields displayed in the Resistance Calibration screen:

RESISTOR - specifies the internal reference resistor to be measured

CHANNEL - is the front channel input to which the standard resistor is connected.

STANDARD RESISTANCE - is the calibrated resistance value of the standard resistor.

The START (F1) function key begins the resistance calibration. As the test proceeds, the screen indicates the status of the process. The user may press the CANCEL (F5) function key or EXIT key to cancel the test.

The resistance calibration uses the sensing current for which the resistor's Absolute Resistance Uncertainty is specified. During the resistance calibration the digital filter is disabled and the timing is set to the Precision settings so that results will be consistent and accurate. Normal temperature measurement and data recording is suspended. Settings are automatically restored after the test. The reported measurement is the mean of a series of samples of the resistance acquired over a period of about 1 min.

When the measurement is completed, the screen shows the results, which includes the following:

MEASUREMENT - is the measured resistance of the standard resistor. This may be compared to the calibrated resistance of the standard resistor to provide an indication of the accuracy of the internal reference resistor.

ABSOLUTE ERROR - is the difference between the measurement and the Standard Resistance value, presented in ohms.

RELATIVE ERROR - is the difference between the measurement and the Standard Resistance value, divided by the Standard Resistance and multiplied by a factor of one million to produce a value in parts per million (ppm).

STANDARD ERROR - is the standard deviation of the samples comprising the measurement, divided by the square root of the number of samples. This provides an estimate of the standard uncertainty of the measurement mean due to measurement noise. It does not include uncertainty of the calibrated resistance of the standard resistor.

TIME - is the time at which the test ended, taken from the system clock. It is in 24 hour format.

DATE - is the date on which the test ended, taken from the system clock. It is in the format specified by the Date Format setting in the User Settings screen.

Tolerances for the reported error, which are required for assessing pass or fail conditions, may be found in the Absolute Resistance Uncertainty section of the Specifications section.

The results of the resistance calibration may be written to a file on a USB memory device using the WRITE FILE (F1) function key as explained below.

The calibration parameter associated with the calibrated internal reference resistor may be adjusted to improve the accuracy of the resistor using the ADJUST RESISTOR (F2) function key as explained below.

9.5.1 WRITE FILE (F1)

The Write File function allows the user to write the results of the resistance calibration to a file on the USB memory device.

The user may change the file name by pressing the ENTER key and using the Alpha-Numeric Interface. Once the file name is set, and after the USB memory device is inserted into the front USB port, the user presses the CONTINUE function key to proceed to write the file. The file is stored in a folder named “\159x\test”. If the file already exists, the new test results are added to the file.

The results of the resistance calibration are written to the file as follows:

RESISTANCE,<Rs>,<chan>,<standard>,<measurement>,<error>,<SE>,<date and time>

<Rs> is the nominal resistance of the internal reference resistor (in Ω).

<chan> is the channel number to which the standard resistor was connected.

<standard> is the calibrated resistance of the standard resistor.

<measurement> is the measured resistance of the standard resistor.

<error> is the error of the measurement compared to the calibrated resistance of the standard resistor, in units of ohms.

<SE> is the standard error of the reported error, in units of ohms.

<date and time> is the date and time of the test. The date is in the format YYYY-MM-DD. The time is in 24-hour format.

9.5.2 ADJUST RESISTOR (F2)

The Adjust Resistor function allows the user to apply an adjustment to an internal reference resistor's calibration parameter to improve its accuracy based on the results of the resistance calibration.

The Adjust Resistor function is always password protected. The user will be prompted to enter the correct password to continue.

The Adjust Resistor screen shows the resistor that will be adjusted, the prior value of its calibration parameter, and the new value of the calibration parameter. The user presses YES (F4) to change the calibration parameter. The user may press the NO (F5) function key or the EXIT key to cancel the change.

When the calibration parameter is updated, the Calibration Date setting is also updated to the present date (see Calibration Parameters in the Menus and Screens section). This can be overwritten by manually entering a date and pressing the EXIT key to save the value.

9.6 CALIBRATION PARAMETERS (F5)

The calibration parameters may be viewed or adjusted by pressing the Calibration Parameters (F5) function key. If a password is not entered, the user will be allowed to only view the parameters. Adjustment cannot take place unless a password is entered. It is recommended to only adjust the calibration parameters as part of the previously described calibration functions. Failure to enter the calibration parameters correctly will cause the Super-Thermometer to measure with error.

If it is required to manually adjust the calibration parameters, press the ENTER key to save each change.

See the Ratio Calibration and Resistance Calibration sections for more information on the resistance calibration parameters and linearity calibration parameters.

The SI UNIT LOCK setting is used to enable or disable °F as an allowed temperature unit option. When this is set to ON, temperatures may be displayed in units of °C and K only, and °F will not be available as an option for the Unit setting (see System Menu, Temperature Unit, in the Menus and Screens section)

9.6.1 Calibration Interval

Ratio Self-Calibration can be performed as often as needed to ensure proper ratio performance. Since no additional equipment is needed for Ratio Self-Calibration, it can be performed at the user's convenience, as often as necessary. Minimally, it should be checked every 6 months during the first year of use and an alignment performed as needed.

Internal Resistor Calibration should be performed on a 6-month interval during the first year of use. After the first year, a 12-month interval is recommended.

9.6.2 Standby Current Check

It may be necessary to check standby current to ensure proper operation. The standby current must be manually checked. Each channel's standby current can be checked with the following steps.



NOTE: *If a scanner is connected, channel 1 will not be available to test. Power off the Super-Thermometer and disconnect the scanner in order to test standby current on channel 1.*

1. Connect a 100 Ω resistor to channel 1.
2. Press the SETUP key and disable all other channels except channel 4.
3. Highlight Channel 1 and press CHANNEL SETTINGS (F2). Set REFERENCE RESISTOR to 100 Ω . Set SENSING CURRENT to 1.0 mA. Set STANDBY CURRENT to ON.
4. Press and hold the EXIT key to return to the Measurement screen. Select the START MEASUREMENT (F1) function key. The Channel Select Key should be amber above channel 1 and green above channel 4. The amber color indicates the channel is in the standby current mode. The current can now be measured by inserting a current meter in series between the C1 or C2 terminal and the 100 Ω resistor lead. An alternative method is using a volt meter to measure the voltage drop across the 100-ohm resistor and then compute the current.
5. Calculate the difference (or error) between the actual 1.0 mA and the measured readings. Error should be less than +/- 0.05 mA.
6. Repeat steps 1 through 5 for the other channels.

10 Maintenance

Avoid operating the instrument in excessively wet, oily, dusty, or dirty environments. If the outside of the instrument becomes soiled it may be wiped clean with a damp cloth and mild detergent. **DO NOT** use harsh chemicals on the surface that may damage the paint or plastic.

- The instrument should be handled with care. Avoid knocking, dropping, or vibrating the instrument.
- This instrument is tested and calibrated at the factory. Continued regular testing and calibration is recommended.
- Routinely check the ratio accuracy using the Ratio Self-Calibration function.

11 Troubleshooting

The purpose of this section is to help the user troubleshoot unexpected operation results. Use the following list of problems and solutions to troubleshoot the issue. If the issue cannot be resolved using this section, contact the nearest Fluke Authorized Service Center for additional support.

Problem	Solution
Failure to produce valid measurements	<p>Check probe wiring. Use an ohmmeter to check continuity of the 4-wire connection to the probe. Verify that one common pair of the 4-wire connection is connected to P1 and C1 terminals while the other pair is connected to the P2 and C2 terminals.</p> <p>Make sure the probe or resistor is connected to the same channel indicated by the channel number in the upper left hand corner of the screen. Check to make sure the correct reference resistor is selected. If an external reference resistor is selected, ensure it is connected to either Rs1 or Rs2 on the back panel or either channel 2 or 4 on the front panel.</p> <p>Check the reference resistor definition to ensure it has been correctly configured.</p> <p>Try connecting a resistor or shorting the input to see if it measures. Try setting the conversion to resistance first.</p> <p>If the Super-Thermometer is able to measure resistance correctly but displays “.” for temperature, there may be an error with the conversion type or characterization coefficients. Check these carefully. The resistance of the probe may be outside the range of the selected conversion type and coefficients.</p> <p>Make sure probe leads are not shorted to other DWF connectors.</p> <p>Run System Test to ensure the hardware is working properly. If System Test does not pass, contact the nearest Fluke Authorized Service Center.</p>
Multiple channels are enabled but only one channel measures.	<p>To measure multiple channels the unit must have the scan function enabled. Turn on Scan Enable in the Scan Settings screen of the Measure menu.</p>
Excessive measurement noise	<p>The current may be too low. Check the current setting by pressing the SETUP key and viewing the excitation current setting for each channel.</p> <p>The reference resistor selection may be incorrect. Check the assigned reference resistor for each channel by pressing the SETUP key and viewing the Rs selection.</p> <p>A faulty measurement connection can be a source of noise. Check the connection by gently tugging the connector on each wire and inspecting for possible wire breaks.</p> <p>The digital filter may not be configured correctly.</p> <p>The Timing Settings may be too fast. Try setting the Sample Period to a longer setting. This may also help when scanning multiple channels.</p> <p>Make sure there are no strong sources of electromagnetic interference near the Super-Thermometer or devices connected to it. Use measurement cabling that is shielded. Attach the shield wire of the cable to the Ground DWF connector.</p> <p>Try attaching a ground wire between the Ground DWF connector on the Super-Thermometer and the chassis of the temperature source.</p> <p>Room temperature variations or air drafts near the Super-Thermometer may cause measurement instability. Locate the instrument in a stable environment.</p>

Problem	Solution
Poor accuracy	<p>The current may be too low causing poor signal to noise ratio or too high causing excessive self-heating. Check the current setting by pressing the SETUP key and viewing the excitation current setting for each channel.</p> <p>The reference resistor selection may be incorrect. Check the assigned reference resistor for each channel by pressing the SETUP key and viewing the Rs selection.</p> <p>The Timing Settings may be too fast. Try setting the Sample Period to a longer setting. This may also help when scanning multiple channels.</p> <p>The temperature conversion type or probe characterization coefficients may be in error. Check each of the probe parameters carefully. Use the Test Calculation function and compare the results with the probe's calibration report table.</p> <p>Make sure probe leads are not shorted to other DWF connectors.</p> <p>Verify the reference resistor calibration value is entered correctly.</p> <p>Make sure the probe wires are properly and tightly connected</p> <p>If using extremely long measurement cables, the capacitance in the wires can affect the readings. Try setting the measurement timing parameter sample period to the longest setting to allow for the measurement to settle.</p> <p>Check the oven stability indicator on the Measurement screen. After 30 minutes from power up the indicator should change from SETTling to READY. If the oven stability indicator never changes to READY, contact a Fluke Authorized Service Center. The unit could still be used with an external reference resistor since the internal oven has no affect when using external resistors.</p>
Graph of measurements jumps or stair-steps	This is normal if the temperature being measured is increasing or decreasing faster than the digital filter is able to track. To eliminate this effect, temporarily disable the digital filter.
The display shows negative resistance.	The measurement cable is not connected correctly.
The USB memory stick does not work	<p>Plug the memory stick into the front panel USB port and wait for about 10 seconds for the system to recognize the device. When recording data to the memory stick wait for the flashing read/write LED on the memory stick to stop flashing before removing it.</p> <p>Make sure the memory stick is formatted to Fat 32. This can be done by inserting the memory stick into a personal computer and right clicking on the drive letter of the memory stick and selecting properties.</p> <p>Make sure the memory stick is compatible with the Linux operating system 2.6 or greater.</p>
Unit will not power up.	<p>Make sure the main power switch located on the back of the unit is turned on</p> <p>Check the fuses in the back of the unit</p> <p>Check the power cord</p>
The display is in the wrong language	If the Super-Thermometer is inadvertently set to the wrong language the user can open the User Settings screen in English by pressing and releasing the ENTER key and then pressing and releasing the SETUP key. Select the correct language if necessary.
Screen is blank	<p>The screen saver may be on. Press any button to turn the screen back on.</p> <p>The system may be in standby. Press and release the Power Standby key on the front panel to bring the unit out of standby mode.</p>
Keypad does not respond	<p>The keypad has been locked by a remote operation command. The keypad can be unlocked by sending the following command to unlock it.</p> <p>SYST:KLOC 0</p>
Resistance statistics field is blank when measuring in ratio mode	When in ratio mode, the Super-Thermometer will not produce a resistance reading. If both measurements are required, set the Super-Thermometer to measure resistance and select ratio as one of the statistics fields.

11.1 CE Comments

11.1.1 EMC Directive

Hart Scientific's equipment has been tested to meet the European Electromagnetic Compatibility Directive (EMC Directive, 2004/108/EC). The Declaration of Conformity for your instrument lists the specific standards to which the unit was tested.

The instrument was designed specifically as a test and measuring device. Compliance to the EMC directive is through EN 61326-1 *Electrical equipment for measurement, control and laboratory use – EMC requirements (2006)*.

As noted in the EN 61326-1, the instrument can have varying configurations. The instrument was tested in a typical configuration with shielded and grounded probe and RS232 cables. Emissions may, in non-typical applications, exceed the levels required by the standard. It is not practical to test all configurations, as the manufacturer has no control over the probes the user may connect to the instrument.

11.1.1.1 Immunity Testing

The instrument was tested to the immunity requirements of the EN 61326-1 according to Table 1 – Minimum immunity test requirements. Criterion A was used for Conducted RF (EN 61000-4-6) and Electric Fast Transit (EFT, Burst, EN 61000-4-4). Therefore, the operation of the instrument may be affected by excessive electromagnetic interference and may not perform within the normal specification limits under these conditions.

11.1.1.2 Emission Testing

The instrument fulfills the CISPR 11 limit requirements for Class A equipment but does not fulfill the limit requirements for Class B equipment. The instrument was not designed to be used in domestic establishments.

11.1.2 Low Voltage Directive (Safety)

In order to comply with the European Low Voltage Directive (2006/95/EC), Hart Scientific equipment has been designed to meet the IEC 61010-1 (EN 61010-1) standards.

Index

Symbols

1.4142 30, 43
10/100 Base T Ethernet 65
24-hour format 50
2590 Scanner 20
°C 50, 56, 108
°F 50, 56, 108

A

ABSOLUTE ERROR 107
Absolute Resistance Accuracy 7
Accuracy
 Measurement Current 7
 Resistance 7
AC power 9
Active Channel 27
ADD PROBE (F1) 34
ADD RESISTOR (F1) 31
ADDRESS 52, 69
ADJUST PARAMETERS (F2) 106
ADJUST RESISTOR (F2) 108
Alert Beep 95
ALERT BEEP 47, 57
alert message 27, 81
ALPHA 35, 86
Alpha-Numeric Interface 23
Alternate Reference 91
ALTERNATE REFERENCE 39
Applying the Specifications 9
arrow keys 18, 23
ASCII 70
ASCII code 10 52
ASSIGN PROBE (F1) 29, 61
ASSIGN RESISTOR (F1) 31
ASTM-E-1137 35
Audio Indication 83
AUDIO INDICATION 40, 44
Authorized Service Centers 2
AUTOMATIC CENTERING 49
AUTOMATIC SCALING 49
average 77
Average Count 93
AVERAGE COUNT 41
AVERAGE ENABLE 40
Averaging 39

B

banana jacks 58
bare wire 58
baud rate 51, 69, 95
BETA 35, 86
brightness 47, 57

C

C1 59
C2 59
CALCULATION 30
Calibrating an SPRT 12
calibration 103
 internal resistors 106
 linearity 104
calibration date 76
Calibration Date 50, 86, 89
CALIBRATION DATE 31, 35, 56
CALIBRATION (F5) 55
Calibration Interval 108
CALIBRATION PARAMETERS (F5) 55, 108
CANCEL (F1) 45
CANCEL (F5) 36
CAN/CSA 22.2 No 61010.1-04, Pollution Degree 2 1
carriage return 52
Carry-handle Kit 15
Case 15
Ch2 90
Ch4 90
CHANNEL 44, 45, 104, 107
Channel Select Key 18, 29
CHANNEL SETTINGS (F2) 30, 61
CHANNEL SETUP 28
CHANNEL SETUP (F1) 29
Chinese 15, 19, 47, 82
CLEAR ERRORS (F1) 52
CLEAR FILTER (F1) 41
CLEAR GRAPH/CLEAR MESSAGE (F4) 28
CLEAR INTERFACE (F1) 69
COMBINED GRAPH 49
Combining the Uncertainties 12
Command Syntax 70
COMPUTER 21, 65
CONFIG (F3) 52
Configuring an External Reference Resistor 62
Connecting a Probe 58
Control Enable 96
CONTROL ENABLE 52
Conversion 86
CONVERSION 35, 40
COPY PROBE (F2) 36
Countdown Timer 27
CURRENT 26, 104
Current Test 103
CURRENT TEST (F2) 55, 103
CVD-ABC 35, 86
CVD-ALPHA 35, 86

D

Data/Graph Section 27
Date 50
DATE 45, 48, 50, 58, 107
Date Format 50, 81

DATE FORMAT 47, 57
Daylight Saving 100
DAYLIGHT SAVING 51, 58
DECIMAL FORMAT 47, 57
decimal point 18
Decimal setting 81
DEFINE RESISTOR (F2) 31
DEL 23
DELETE 24
DELETE CONFIG (F3) 54
DELETE key 18
DELETE PROBE (F5) 38
DELETE RESISTOR (F5) 33
delta 80
DELTA 35, 48, 86
DELTA CHANNEL 49
Delta Mode 80
DELTA MODE 49
Delta Offset 80
DELTA OFFSET 49
Depth 9
DHCP 51, 65, 96
DHCP ENABLE 51, 66
dielectric absorption 40
digital filter 93
Digital Filter 41
Digital Filter Description 41
DIGITAL FILTER (F3) 41
Dimensions 9
display 47
Display 19
DISPLAY BRIGHTNESS 47, 57
DISPLAY INTERVAL 40
Display Menu 46
DISPLAY MENU 29
DISPLAY MENU (F4) 46
dR/dT 11
DRIFT 45
dT/dW 11
Due Date 89
DUE DATE 31
DVD 15
dW/dT 11
DWF connectors 58

E

Earth Ground 22
EDIT PROBE (F3) 36
EDIT RESISTOR (F2) 32
EN 61010-1 {2nd Edition} 1
English 15, 19, 47, 82
ENTER 18, 23
EOI 52, 69
ERASE DATA (F5) 43
ERRORS (F5) 52
Ethernet 21, 51, 65

excitation current 30
EXIT 18
EXP 18, 23
exponential number 18
Extended range test 15
External Reference Resistor 62
external resistor 20, 30

F

FAT32 17
FIELD SETTINGS (F2) 48
FILE NAME 53
Filter Enable 93
FILTER ENABLE 41
Filtering 39
firmware 54, 95
Firmware Version 50
Fluke Corporation ii
French 15, 19, 47, 82
Front Panel 17, 19
front-panel key lock 98
Front Panel Keys 18
Function Keys 18
Fuse Rating 9
Fuses 15
Future Peripheral 21

G

G 59
GATEWAY 51
Gateway Address 67, 96
German 15, 19, 47, 82
Getting Started 57
GPIB 95
Graph 49
GRAPH SETTINGS (F4) 49
Guard 59
GUM 5

H

HARDWARE MAC 51
Hardware Mac Address 66
Height 9
Host Name 67, 97
HOST NAME 52
HTML 51, 65

I

ID 34
IEC 625 21
IEC-751 35
IEEE-488 21, 52, 65, 69, 95
IEEE-488 (F4) 52
IFC 52
Inspection 15
Instruction Manuals 15

Interface Commands 70
INTERNAL 53
Internal Memory 41, 42
Internal Resistor Calibration 108
IP address 51, 66
IP Address 96
IP ADDRESS 51
ISO Guide to the Expression of Uncertainty in Measurement 5
ITS-90 9, 27, 35, 83, 86
ITS-90 SUBRANGE ALERT 47, 57

J

Japanese 15, 19, 47, 82

K

K 50, 56, 108
Key Beep 95
KEYPAD BEEP 47, 58

L

LAN 21, 65
Language 19
LANGUAGE 47, 57
Language setting 82
leakage 40
limited 79
LIMITED 49
Limited mode 49
linearity 6, 104
LINEARITY C1 106
LINEARITY C2 106
LINEARITY C3 106
LINEARITY C4 106
LINEFEED 51, 52, 69
Line Power 16
line voltage 15, 22
Linux 17
Local Area Network 65
Location Descriptor 23

M

MAC address 51
Main Menu 28
Maintenance 111
Making Measurements 61
MANAGE PROBES (F5) 37
MANAGE RESISTORS (F3) 32
Manufacturer 50
maximum 78
MAXIMUM 48
Maximum Current 30, 86, 89
MAXIMUM CURRENT 31, 35
Maximum operating altitude 9
MAXIMUM TEMPERATURE 35
mean 77
MEAN 45, 48

MEAN 1 45
MEAN 2 45
MEAN 3 45
MEASUREMENT 107
Measurement Current Accuracy 7
Measurement Inputs 17
measurement noise 8, 12, 40
Measurement Progress Bar 27
Measurement range 9
Measurement Screen 25
Measure Menu 38
MEASURE MENU 28
MEASURE PROTECTION 55
MEASURE TIME 44, 63
Measuring an SPRT 10
Measuring a PRT 13
Measuring a Temperature Probe 61
Measuring a Thermistor 14
Measuring Resistance Ratio 62
MEMORY DEVICE 42, 53
MENU 18
Menu Navigation 24
Menus 23
Menu System 24
minimum 78
MINIMUM 48
Model 50
MOVE DOWN (F4) 33, 38
MOVE UP (F3) 33, 38
moving window 79
Multiplexer 20

N

n 79
N 48
Network 51
NETWORK (F3) 51
Network port 51
nominal current 30, 43, 86
NOMINAL CURRENT 35
non-volatile 41
numeric keys 18

O

Operating relative humidity 9
operating temperature 9
oven 89
OVEN 27

P

P1 59
P2 59
password 24, 99
PASSWORD 54
PASSWORD (F4) 54
PEM 15, 22

PHASE 45
POLARITY 104
POLYNOMIAL 35, 36
PORT ENABLE 51, 52, 69
port number 65
Power Entry Module 15
Power Standby key 18
PRESET FAST 92
PRESET FAST (F3) 41
PRESET LONG 92
PRESET LONG (F4) 41
PRESET NORMAL 92
PRESET NORMAL (F1) 40
PRESET PRECISION 92
PRESET PRECISION (F2) 41
PROBE 45
probe definition 29, 61, 85, 86
Probe Definitions 54
PROBE ID 26
Probe Library 29, 34, 37, 54, 61, 85, 86
Probe Library Capacity 38
Probe Menu 34
PROBE MENU 28
PROBE MENU (F2) 34
PROBE PROTECTION 54
PRT 34
PT-100 35, 86

Q

Queue overflow 52

R

R0 35, 86
Rack Mounting 16
Rack Mount Kit 15
ratio 9, 39, 55, 104
RATIO 30, 48
Ratio Accuracy 6, 10
RATIO CALIBRATION (F3) 55, 104
Ratio Self-Calibration 55, 100, 101, 104, 108
READ FILE (F1) 32, 37
READ FILE (F3) 43
READ PROBE (F4) 37
READ RESISTOR (F3) 32
READY 27
Rear Panel 17, 20
rear USB 68
RECALL CONFIG (F2) 53
recording 81
Recording 27
Recording Menu 41
RECORDING MENU (F4) 41
RECORDING SETTINGS (F1) 42
Record Statistics 80
RECORD STATISTICS 42
REFERENCE CHANNEL 39

reference resistor 30, 62
Reference Resistor Drift 12
REFERENCE RESISTOR (Rs) 30
RELATIVE ERROR 107
Relative Measurement Current Accuracy 8
Remote Interface 51
REMOTE INTERFACE (F2) 51
Remote Operation Connections 21
Repeat Count 91
REPEAT COUNT 39
REPEAT NOMINAL 44, 63
Report Operation Commands 70
RESET STATISTICS (F3) 28
Resistance 89
RESISTANCE 30, 48
Resistance Accuracy 7, 11, 13
resistance calibration 106
RESISTANCE CALIBRATION (F4) 55, 106
Resistance Ratio Temperature 30
RESISTANCE VALUE 31
RESISTOR 34, 107
resistor definition 31
resistor definition library 31
Resistor Definitions 55
RESISTOR ID 31
Resistor Library 55
RESISTOR PROTECTION 55
Resistor Stability 6
RESTORE DEFAULT (F4) 54
Rs 9, 27, 30
RS 26
Rs1 20, 62, 90
Rs2 20, 62, 90
RS-232 21, 65, 69
Rs DUE ALERT 47, 57
Rs inputs 17
R(T) 87
RT90 9
R(T) POLYNOMIAL 36
RTPW 9, 86
Russian 15, 19, 47, 82
Rx 9

S

Safety Information 1
Sample Count 49
SAMPLE COUNT 49
Sample Period 39, 40, 92
SAMPLE PERIOD 40
sample size 79
Sampling 39
SAVE (F2) 36
Scan Enable 90
SCAN ENABLE 39
scan list 91
Scanner 20

Scanner Connection 20
scanning 90
Scanning 62
SCAN SETTINGS (F1) 39
Screens 23
Screen Saver 47
SCREEN SAVER DELAY 47, 57
SCREEN SAVER ENABLE 47, 57
SDC 52
self-heating 30, 43, 63
SELF-HEATING 45
sensing current 30, 40, 84, 103
SENSING CURRENT 30, 45
SENSING CURRENT 1 45
SENSING CURRENT 2 45
SENSING CURRENT 3 45
Sensing Current Test 100
SE OF MEAN 48
SERIAL (F1) 51
Serial Number 50
serial port 21, 69
SETTLE TIME 44, 63
SETTLING 27
SETUP key 18, 29
SET UP Rs (F1) 31
SHOW TABLE/GRAPH (F2) 28
sign key 18, 23
SI Unit Lock 50
SI UNIT LOCK 56, 108
sliding window 49
spade connectors 58
Spanish 15, 19, 47, 82
Specifications 5
spread 79
SPREAD 48
standard deviation 48, 78
STANDARD ERROR 45, 107
standard error of the mean 48, 79
STANDARD RESISTANCE 107
standby 18
Standby Current 30, 84
STANDBY CURRENT 30
Standby Current Check 109
START (F1) 44
START/STOP MEASUREMENT (F1) 28
START/STOP RECORD (F5) 28
Start-up Help 82
START-UP HELP 47, 58
static IP address 66
Statistics 48, 49
Statistics Fields 27
STATISTICS MODE 49
STATISTICS SETTINGS (F3) 49
Status and Alert Section 27
STD DEV 45, 48
STD DEV 1 45

STD DEV 2 45
STD DEV 3 45
STEP 45
stop timer 40, 84
STOP TIMER ENABLE 40
Storage relative humidity 9
storage space 53
Storage temperature 9
STORE CONFIG (F1) 53
Subnet Mask 67, 97
SUBNET MASK 52
Subrange 1 35
Subrange 2 35
Subrange 3 35
Subrange 4 35
Subrange 5 35
Subrange 6 35
Subrange 7 35
Subrange 8 35
Subrange 9 35
Subrange 10 35
Subrange 11 35
Symbols Used 1
system clock 50
System Menu 50
SYSTEM MENU 29
SYSTEM MENU (F5) 50
system self-test 102
SYSTEM TEST (F1) 55, 103
SYST:ERR? 52

T

TCP/IP 51, 65
TCP port number 5025 65
TEMPERATURE 30
Temperature Resolution 82
TEMPERATURE RESOLUTION 47, 57
temperature unit 56, 102
TEMPERATURE UNIT (F5) 50
Terminal Screen 68
TERMINATION 52, 69
TEST CALCULATION (F1) 36
text field 23
thermal response 40
THERMISTOR 34, 36
Time 50, 99
TIME 45, 48, 50, 58, 107
TIME DATE (F1) 50
TIME/DATE PROTECTION 55
Timer Beep 83
TIMER DURATION 40
TIME REMAINING 45
TIME SPAN 49
Timing 39
TIMING SETTINGS (F2) 39
T(R) 87

TRACE 50
T(R) POLYNOMIAL 36
TYPE 34

U

Unit 56
UNIT 50
unlimited 79
UNLIMITED 49
Unlimited mode 49
Unpacking 15
UPDATE FIRMWARE (F5) 54
USB 17, 21, 32, 41, 42, 53, 65, 81, 97
 rear 68
USB (F2) 51
USB FILE 42
User Settings 19
USER SETTINGS (F1) 47
User Settings Screen 57
User's Guide 15

V

VARIABLE RESISTANCE 31
VERTICAL CENTER 49
VERTICAL SPAN 49
VIEW DATA (F2) 42
VIEW PREVIOUS (F2) 46

W

warm-up period 9, 18
Warnings 1
Warranty ii
Web Interface 21, 68
web page 52
Weight 9
Width 9
WRITE FILE (F2) 32, 37
WRITE FILE (F4) 43
WT90 9

Z

Zero-Power 8, 13, 30, 43, 63
ZERO-POWER MEASUREMENT (F5) 43
ZERO-POWER RESULT 45